

# UNHCR

UNITED NATIONS HIGH COMMISSIONER  
FOR REFUGEES

# IN REFUGEE SITUATIONS



PTSS / UNHCR  
*Geneva*



ISS / WHO  
*Rome*

*April 1997*

# **UNHCR**

UNITED NATIONS HIGH COMMISSIONER  
FOR REFUGEES

## **VECTOR AND PEST CONTROL IN REFUGEE SITUATIONS**

- arthropods vectors and nuisances
- snails as intermediate hosts of schistosomes
- commensal rodents

**in Africa**

PTSS / UNHCR  
Geneva

ISS / WHO  
Rome

April 1997

This work was compiled by Dr. **Guido SABATINELLI**, a researcher at the *Istituto Superiore di Sanità* in Rome (ISS), in collaboration with the Programme and Technical Support Section (PTSS) of UNHCR.

### **Acknowledgements**

UNHCR wishes to express its gratitude to the *Istituto Superiore di Sanità*, a WHO Collaborating Centre for Human Resources and Educational Technology Development for the Control of Tropical Diseases (ISS/WHO, Rome), for its valuable contribution to the publication of the present version of this manual.

UNHCR and ISS/WHO would like to thank the many groups and individuals that contributed to preparing this work, in particular the staff of UNHCR and the NGOs that, from November 1994 to July 1995, participated in the Rwanda operation.

We would also thank Rob McLeod (Ontario, Canada), and Mike Lehane of the University of Wales (Bangor, UK) for editorial assistance.

Copies of this publication can be obtained through your nearest UNHCR office, or by writing to the following address:

**PTSS**

**UNHCR Headquarters**

**P.O. Box 2500**

**CH-1211 Geneva 2 Dépôt, Switzerland**

**Fax: (+41 22) 739 7371**

This manual, originally published in French by ISS/WHO, may be freely reproduced or translated into other languages, provided that it is distributed free-of-charge and that ISS/WHO and UNHCR are mentioned as the original source.

ISS/WHO (Rome) and PTSS (Geneva) would appreciate receiving copies of any adaptation or full or partial translation of this manual, PTSS at the above address and ISS/WHO at:

**ISS/WHO, Department of Parasitology**

**Viale Regina Elena 299**

**I-00161 Rome, Italy**

## PREFACE

This manual grew out of the events which occurred in the Great Lakes region of East Africa (Rwanda, Burundi, Tanzania, Uganda and Upper-Zaire). It reflects the vector-control problems encountered in the refugee camps of the region and proposes a systematic approach to resolving them in the short term through chemical means and, over the long term, through environmental sanitation combined with health education for the communities concerned.

Pest and vector control is a subject to which numerous guides, manuals and other publications have been and will continue to be devoted. Such an abundance of literature reflects the number and importance of the diseases transmitted by vectors and the constant progress being made in the technologies for controlling them, particularly in pesticide technology. However, the fact that pesticides play an important role in vector control should not cause us to lose sight of the potential danger they represent for human health and the environment.

Although every refugee situation is unique in the way it develops and in the type of population concerned, there are, nevertheless, certain common aspects relating to health, hygiene and the environment. The same health problems, along with the same types of vectors and pests, are often present in the early days of refugee movements into high-density sites. This, in principle, favours the use of the same vector control strategies with adaptation, as required, to specific environmental conditions as well as to human, material and financial resources.

It is planned that this manual will be adapted to other situations in other regions (in Africa or elsewhere) where health is at risk owing to the insufficient or inadequate control of vectors and other pests.



Giancarlo Majori  
Director  
Department of Parasitology  
Istituto Superiore di Sanità



---

Nicholas Morris  
Director  
Division of Operational Support  
United Nations High  
Commissioner for Refugees

# TABLE OF CONTENTS

	Pages
<b>1. Introduction</b> .....	5
<b>2. Factors influencing the spread of vectors in refugee camps</b> .....	6
<b>3. Arthropods of medical importance</b> .....	8
<b>4. Mosquitos</b> .....	10
4.1. Biology .....	10
4.2. Collecting and sampling .....	12
4.3. Diseases transmitted .....	13
4.4. Hygiene measures and health education .....	15
4.5. Chemical control .....	15
4.5.1. Larvicides .....	16
Targets .....	16
Insecticides .....	16
Application methods .....	17
Frequency of treatment .....	18
4.5.2. Adulticides with a residual effect .....	18
Targets .....	18
Insecticides .....	18
Application methods .....	19
Frequency of treatment .....	19
4.6. Mosquito nets and curtains impregnated with insecticides .....	20
4.6.1. Impregnated mosquito nets .....	20
4.6.2. Impregnated curtains .....	20
4.6.3. Impregnated wall fabrics .....	21
4.6.4. Impregnation .....	21
Insecticides .....	21
Method of impregnation and installation .....	21
Frequency of re-impregnation .....	22
<b>5. Non-biting flies</b> .....	23
5.1. Biology .....	23

5.2.	Collecting and sampling .....	24
5.3.	Diseases transmitted .....	24
5.4.	Hygiene measures and health education .....	24
5.4.1.	Construction and maintenance of latrines .....	24
5.4.2.	Management of domestic garbage .....	26
5.4.3.	Preventing access by flies .....	27
5.4.4.	Using traps .....	27
5.4.5.	Health Education .....	29
5.5.	Chemical control .....	29
5.5.1.	Treatments with residual effects .....	29
	Targets .....	29
	Insecticides .....	30
	Application methods .....	30
	Frequency of treatment .....	30
5.5.2.	Direct contact spraying .....	31
	Targets .....	31
	Insecticides .....	31
	Application methods .....	31
	Frequency of treatments .....	31
5.5.3.	Larviciding .....	31
	Targets .....	32
	Insecticides .....	32
	Frequency of treatment .....	32
5.6.	Biological control .....	32
<b>6.</b>	<b>Lice</b> .....	<b>33</b>
6.1.	Biology .....	33
6.2.	Diseases transmitted .....	33
6.3.	Hygiene measures and health education .....	34
6.4.	Chemical control .....	34
	Targets .....	34
	Insecticides .....	34
	Application methods .....	34
	Equipment and materials .....	35
	Frequency of treatment .....	36
<b>7.</b>	<b>Fleas</b> .....	<b>37</b>
7.1.	Biology .....	37
7.2.	Collecting and sampling .....	37
7.3.	Diseases transmitted .....	38
7.4.	Hygiene measures and health education .....	38

7.5.	Chemical control .....	38
	Targets .....	39
	Insecticides .....	39
	Application methods .....	39
	Frequency of treatment .....	39
<b>8.</b>	<b>Bed bugs</b> .....	<b>40</b>
8.1.	Biology .....	40
8.2.	Collecting and sampling .....	40
8.3.	Medical importance .....	40
8.4.	Control .....	41
<b>9.</b>	<b>Human scabies mites</b> .....	<b>42</b>
9.1.	Biology .....	42
9.2.	Detection .....	43
9.3.	Human scabies .....	43
9.4.	Hygiene measures and health education .....	43
9.5.	Chemical control .....	44
<b>10.</b>	<b>Ticks</b> .....	<b>45</b>
10.1.	Biology .....	45
10.2.	Collecting and sampling .....	46
10.3.	Diseases transmitted .....	46
10.4.	Control .....	46
<b>11.</b>	<b>Other arthropods of medical importance</b> .....	<b>47</b>
11.1.	Cockroaches .....	47
11.2.	Tsetse-flies .....	48
11.3.	Sandflies .....	49
11.4.	Blackflies.....	50
11.5.	Myiasigenic flies .....	50
11.6.	Stablefly .....	51
<b>12.</b>	<b>Snails hosts of schistosomes</b> .....	<b>52</b>
12.1.	Biology .....	52
12.2.	Collecting and sampling .....	52
12.3.	Diseases transmitted .....	52
12.4.	Hygiene measures and health education .....	53
12.5.	Chemical control .....	54
	Targets .....	54
	Molluscicides .....	54

Application methods .....	54
Frequency of treatment .....	54
<b>13. Commensal rodents .....</b>	<b>55</b>
13.1. Biology .....	55
13.2. Medical importance .....	57
13.3. Economic importance .....	57
13.4. Hygiene measures .....	57
13.4.1. Garbage management .....	58
13.4.2. Mechanical protection .....	58
13.5. Traps .....	58
13.6. Chemical control .....	59
13.6.1. Use of rodenticides .....	59
Multiple-dose toxic products (anticoagulants) .....	59
Single-dose toxic products .....	60
13.6.2. Fumigation .....	61
<b>14. Organisation of a control programme .....</b>	<b>62</b>
14.1. Methods .....	62
14.1.1. Objectives .....	62
14.1.2. Strategies .....	62
14.1.3. Indicators .....	63
14.1.4. Role of the Government of the host country .....	64
14.1.5. Community participation .....	64
14.2. Installations .....	65
14.2.1. Storage and transport equipment .....	65
14.2.2. Cleaning of the equipment .....	65
14.2.3. Waste water disposal .....	66
14.2.4. Showering .....	66
14.3. Equipment .....	66
14.3.1. Equipment for the application of solutions .....	67
Hand compression sprayers .....	67
Lever-operated sprayers .....	69
Backpack motorised mistblowers .....	69
14.3.2. Equipment for the application of solid materials .....	71
Hand-carried dusters .....	71
Backpack motorised dusters .....	71
14.4. Personnel .....	71
14.4.1. Organisational flowchart .....	72
Section leader .....	72
Team leader .....	72



Spray personnel .....	73
14.4.2. Training .....	73
14.5. Supervision and evaluation .....	73
14.5.1. Writing reports .....	74
<b>15. Pesticides .....</b>	<b>75</b>
15.1. Classification and characteristics .....	75
15.2. Toxicity .....	76
15.3. Formulations .....	76
15.4. Resistance to insecticides .....	77
15.5. Legislation .....	78
<b>16. Safe use of insecticides .....</b>	<b>80</b>
16.1. Protection and hygiene of the personnel .....	80
16.2. Pesticide poisoning and first aid .....	81
16.2.1. Organophosphates .....	81
16.2.2. Synthetic pyrethroids .....	81
16.3. Emergency treatment .....	82
16.4. Laboratory tests .....	82
<b>Glossary .....</b>	<b>83</b>
<b>Bibliographic selection .....</b>	<b>88</b>
<b>Annexes</b>	
1. Some arthropods and their importance to health .....	92
2. Morphological characteristics of some arthropods of medical importance .....	94
3. Reporting form for spraying operations .....	98
4. Calculation of the quantity of solution and insecticide for use in treatments .....	99
5. Determination of the insecticide concentration for use in a sprayer .....	100
6. Preparation of a solution from an insecticide formulation .....	101
7. Preparation of a solution from an emulsifiable concentrate .....	102
8. Calculation of the quantity and dilution of insecticide for use in impregnation of fabrics .....	103
9. Calculation of the quantity of molluscicide for use in a waterway .....	104
<b>List of tables</b>	
1. Insecticides suitable as larvicides in mosquito control .....	17
2. Insecticides suitable as residual spray applications against mosquito vectors .....	19
3. Insecticides suitable as residual treatment in fly control .....	30
4. Insecticides commonly employed in the control of cockroaches .....	48

5. Multiple-dose anticoagulant rodenticides .....	60
6. Examples of indicators for estimating vector population density .....	64

**List of figures**

1. Differential characteristics of mosquitos of the genera <i>Anopheles</i> and <i>Culex</i> .	11
2. Diagram of a ventilated improved pit latrine .....	25
3. Diagram of a pit latrine with a slab fitted with a lid .....	26
4. Diagram of a fly trap made from a plastic bottle .....	28
5. Hand-operated dusters .....	35
6. Human scabies mites ( <i>Sarcoptes scabiei</i> var. <i>hominis</i> ) .....	42
7. The soft tick <i>Ornithodoros moubata</i> .....	45
8. Morphological differences between the Norway and the roof rat .....	56
9. Hand compression sprayer .....	68
10. Backpack motorised mistblowers .....	70

# 1. INTRODUCTION

This manual provides information to Vector Control Personnel for their immediate use during crisis situations in refugee camps in East Africa.

The following subjects are treated:

- Problem **arthropods** of the area;
- **Biological** influences on the choice and effectiveness of control methods;
- **Vector-borne diseases** of the area;
- Basic **control methods** and equipment;
- **Pesticide** safety and toxicity.

At the back of this manual is a glossary of scientific terms, a reference list, 9 technical worksheets (annexes), and 32 colour plates illustrating vector control in refugee situations.

## 2. FACTORS INFLUENCING THE SPREAD OF VECTORS IN REFUGEE CAMPS

Although geography and climate have a major influence on the spread of disease-carrying organisms, local conditions can be the main factor in the creation of a human health problem.

Refugee situations are characterised by three factors: time, space and number. When many refugees settle in a small space over a short time, an emergency situation results. Overpopulation, promiscuity, difficult access to health services and water supply, unhygienic conditions, and precarious shelters cause an increase in arthropods and domestic rodents, and promote the spread of communicable diseases (pl. 1-2).

Flies, lice, and fleas are the main vectors and nuisance factors in newly-established refugee camps, whereas bugs, ticks, and domestic rodents do not usually become a problem until the camps have been operating for some time. The nearby presence of standing water may also contribute to the proliferation of mosquitos.

Migrating refugees may carry parasites and diseases (body lice, rickettsioses, or trypanosomiases) from an old location to a new one, thereby contaminating a previously uninfected site. In the same way, they may also spread resistant strains of malaria parasites among native communities. Conversely, healthy refugees arriving at an infected site may come into contact with foreign strains against which they have not developed a specific immunity. This can generate deadly epidemics of malaria, particularly in communities weakened by psychological stress, fatigue, and lack of food.

Refugee camps are often set up in locations where shade and drinking water are available. Unfortunately, these sites are also preferred by various disease-carrying arthropods. Wet or swampy areas are prime development sites of the *Anopheles* mosquito which transmits malaria, acacias provide habitat for the vec-

tor of visceral leishmaniasis, the blood-sucking sandfly, and river banks as well as savannahs are the favoured areas of tsetse-flies, which are the vectors of sleeping sickness.

It is most important that Fact-Finding and Needs & Resources Assessment missions investigate all factors favourable to the development of vectors, and determine the local prevalence and incidence of the diseases they transmit. This information will help in deciding whether to accept or reject new settlement sites, or in applying appropriate control and preventive measures to existing sites.

### 3. ARTHROPODS OF MEDICAL IMPORTANCE

Arthropods are small invertebrate animals with jointed legs. Instead of having an internal skeleton made of bone, they have an external shell-like skeleton made of a tough, rigid material called chitin. Their body parts and appendage segments are joined by flexible membranes which allow the various parts to move.

The majority of arthropods are not harmful to humans. However, a number of species are considered medically important because they can cause annoyance, physical discomfort, or disease in humans. These arthropods can be put into four main categories:

- **Harmful** cause nuisance, discomfort, and/or blood-loss by their bites (mosquitos, bugs, fleas); or cause nuisance by their mere presence (gnats).
- **Ectoparasites** live and feed permanently on the exterior of the host without transmitting germs (head lice, pubic lice, scabies mites).
- **Mechanical transporters** transmit disease passively, by picking up infections from faeces, and then contaminating human food so that disease is contracted orally (flies, cockroaches).
- **Vectors** actively transmit parasitic disease-causing organisms. The pathogen develops and multiplies in the vector, and is transmitted to humans via the arthropod's bite or excreta (mosquitos, tsetse-flies, body lice, fleas).

Arthropods of medical importance include insects (class Insecta) and arachnids (class Arachnida). Of the arachnids, only mites and ticks (order Acarina) are vectors of diseases. Of the insects, five groups are of medical importance: true flies (order Diptera), true bugs (order Heteroptera, or Hemiptera), lice (order Anoplura), fleas (order Siphonaptera), and cockroaches (order Dictyoptera).

Insects can be easily distinguished from arachnids in the following ways:

INSECTS	ARACHNIDS
3 distinct body regions (head, thorax, and abdomen)	2 distinct body regions (cephalothorax, and abdomen)
3 pairs of legs	4 pairs of legs (except larval mites, which have 3 pairs)
often have wings	never have wings
1 pair of antennae	no antennae
segmented abdomen	abdomen usually not segmented

The change in form during an insect's development is called metamorphosis. Insects which undergo complete metamorphosis (example: flies) have four stages of development: egg, larva, pupa, and adult. Insects which undergo incomplete metamorphosis (example: bugs) have three stages of development: egg, nymph, and adult. The nymph looks very much like the adult, but is smaller, its size being roughly proportional to its age.

Annex 1 at the back of this manual lists medically important arthropods found in refugee camps of East Africa. Annex 2 gives identification characteristics of each arthropod group.

The following sections (4 through 11) discuss arthropods: their biology, collecting and sampling methods, transmitted diseases, and control measures which can be applied for each systematic group.

## 4. MOSQUITOS

### 4.1. Biology

Mosquitos are small, two-winged, blood-sucking insects. This is the most important group of insects from a medical point of view. Mosquitos are found near water, where their larvae develop. The biological cycle has four stages: egg, larva, pupa, and adult, the first three of which are aquatic.

The eggs are laid individually either on moist land subject to flooding (in *genus Aedes*) or on the surface of the water (in *Anopheles* and *Aedes*); or they are laid in groups on the water surface (in *Culex*). Eggs laid on water hatch in two or three days, whereas eggs laid on land hatch after they are flooded. The submerged larvae position themselves parallel (*Anopheles*) or oblique (*Culex* and *Aedes*) to the surface of the water, and breathe air through a breathing tube (*Culex* and *Aedes*) or a pair of posterior spiracles (*Anopheles*). The larvae feed on organic matter suspended in the water, and pass through four progressively-larger stages before developing into pupae, which do not feed but release the adult insects after about two days.

The time required to complete all stages of development varies according to species, temperature, and the availability of nutrients. Adult mosquitos are able to mate as soon as they emerge; mating occurs in-flight. Both males and females feed on plant juices, but females also require periodic blood meals in order for their eggs to mature.

When seeking a host from which to draw blood, mosquitos may fly three kilometres or more from their larval development site, and wind-blown mosquitos may travel considerably greater distances. However, the first suitable animal encountered is most often targeted as a source of blood. Generally speaking, the closer a refugee camp is to a mosquito development site, the greater the likelihood of heavy infestation.

Animals give off carbon dioxide when they breathe, and carbon dioxide is the



most important attractant of female mosquitos. When they detect it in the air, they fly upwind toward the source animal(s). Therefore, it is useful to know the direction of prevailing winds in an area, so that camps may be set up downwind of major larval development sites.

There are more than 3,000 species of mosquitos in the world but, in the tropical savannah zone of Africa, the three most important in disease transmission and nuisance are *Anopheles gambiae*, *Anopheles funestus*, and *Culex quinquefasciatus*, which is active only by night. The presence of black spots on the wings of *An.gambiae* and *An.funestus* easily distinguishes them from *Cx.quinquefasciatus*. Also, the body of a resting adult *Anopheles* forms a 45° angle with the supporting surface, whereas that of a *Culex* is parallel (fig. 1). There are also several species of *Aedes* mosquitos in forest zones, and they can be very aggressive biters, even during the day. The *Aedes* species, belonging to *Stegomyia* subgenus, are easily recognised by the presence of white bands on their black legs.

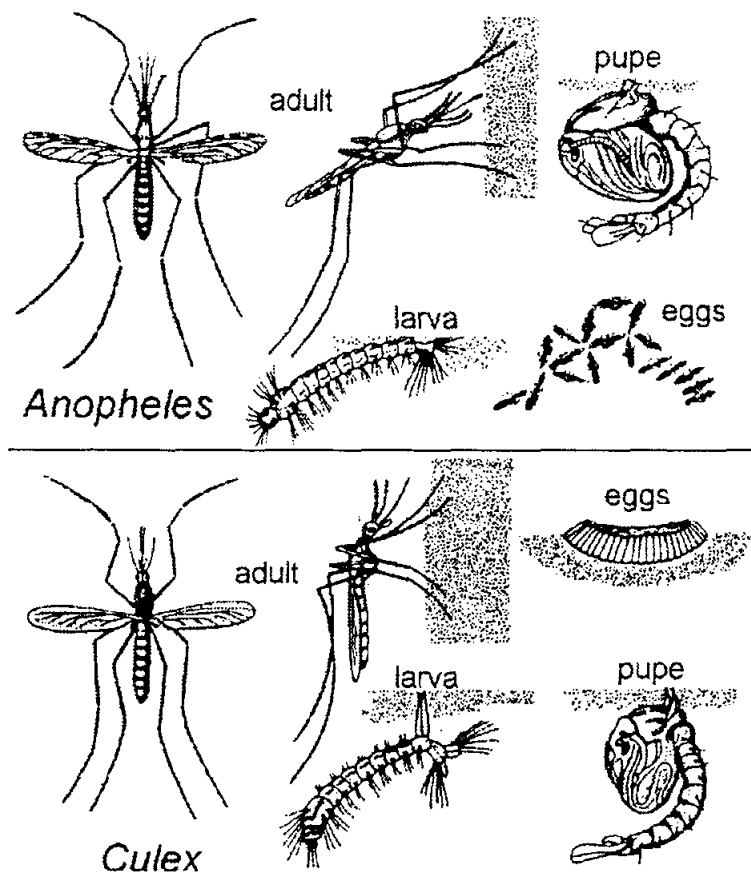

**Figure 1 - Differential characteristics of mosquitos of the genera *Anopheles* and *Culex***

*An.gambiae* develops in the fresh, open water of small temporary pools (pl. 5), or larger bodies of water. Flooded brick holes, although the water they contain may be muddy, provide excellent larval development sites. Population density can increase rapidly during the rainy season. *An.gambiae* actually comprises a complex of species having different biological characteristics and varying capacities for transmitting malaria.

*An.funestus* colonises permanent and shaded collections of water, particularly ponds, paddy fields, and other irrigated plantations. This mosquito is particularly abundant in the dry season.

*Cx.quinquefasciatus* colonises polluted water in waste-water ditches and drains, septic pits, and cesspools. It is present all year round in areas having sufficient water for the development of its larvae.

## **4.2. Collecting and sampling**

The two most practical methods of identifying mosquitos and assessing their numbers are: collecting adults at rest inside dwellings, and sampling larval development sites.

Prospecting larval breeding sites must be done in small pools and along the edge of wide bodies of water (ponds, paddy fields, etc.).

### Larval sampling equipment:

- a fine sieve with a long handle;
- a light-coloured basin;
- a large diameter pipette;
- bottles containing 70% ethyl alcohol or 4% formol.

### Larval sampling procedure:

- filter the collected water through the sieve;
- pour the collected material into the basin containing clear water;
- use the pipette to transfer the larvae to the bottles containing 70% ethyl alcohol or 4% formol;
- send the collected specimens to the laboratory for species identification.

To estimate the number of adult mosquitos and their rate of aggressiveness again-

st humans, mosquitos at rest inside dwellings can be collected after spraying with synthetic pyrethroids.

Adult collecting equipment:

- white sheets or light-coloured plastic sheets;
- pyrethroid insecticide aerosols (spray cans);
- Petri dishes;
- tweezers.

Adult collecting procedure:

- begin between 5 AM and 7 AM, before the mosquitos leave the dwelling;
- close all openings as best as possible;
- spread the sheets on the floor of the room;
- spray the insecticide around the room (never use formulations containing carbamates or organophosphates);
- wait 10-15 minutes; during this time, note the number of persons occupying each room during the night;
- remove the sheets from the room, taking care that the fallen mosquitos collect in the middle;
- using tweezers, transfer the mosquitos to Petri dishes (one box per room) (pl. 6).

The collected samples can be counted and sent to the laboratory for species identification. The number of mosquitos collected divided by the number of rooms examined will give the average density per room; the number of mosquitos collected divided by the number of persons occupying each room will give the average number of mosquitos per person; the number of gorged mosquitos (having blood in the abdomen) divided by the number of persons occupying each room will give the average number of bites per person.

### **4.3. Diseases transmitted**

Malaria is responsible for millions of deaths in Africa each year. There are four plasmodial species which cause malaria (*Plasmodium falciparum*, *P.vivax*, *P.malariae*, *P.ovale*) and these are transmitted solely by mosquitos belonging to the genus *Anopheles*. Plasmodia are sucked up by female mosquitos as they feed on blood, but only the sexed form survive and reproduce in the gut lining of the mosquito. Plasmodial sporozoites develop and are released from the gut lining,

and stored in the salivary glands of the mosquito until they are injected into a human at the beginning of the mosquito's next blood meal. The development of *Plasmodium* inside the mosquito is strongly influenced by environmental temperatures: development takes 10-11 days at the optimum temperature of 30°C, and stops at temperatures below 18°C (in *P.falciparum*), or less than 16°C (in *P.vivax*, *P.malariae*, and *P.ovale*). Because temperature is a controlling factor, malaria is generally more common at lower (warmer) elevations. Nevertheless, epidemiological studies have found great differences in the prevalence of malaria in different ecological zones. It is most prevalent in rice-producing areas where irrigated lands support high mosquito population densities, and it reaches its highest incidence at the end of the rainy season.

In Africa, malaria has historically been a major cause of sickness and death in rural areas. Presently, it accounts for 15-30% of medical consultations, 15-20% of hospitalisations, and about 5% of deaths. The seriousness of the disease depends on the level of immunity of the patient, attained through previous exposure to different species and strains of plasmodia. When on the move, refugees often encounter strains against which they have not developed specific immunity, and this can give rise to very serious epidemics. The stresses caused by lack of food and interpersonal conflicts can further weaken the immune response of refugees, making them more vulnerable to disease.

In refugee camps, "fevers of unknown origin" (FUOs), are the major cause of sickness, and are among the leading causes of death. All reported cases of FUOs are attributed to malaria whenever there are no facilities available for microscopic diagnosis. Therefore, the number of true cases of malaria is most likely fewer than that claimed.

In East Africa, in refugee camps located below 1'600 metres, climatic conditions are favourable to the transmission of malaria, but transmission levels can vary widely between the camps according to the local ecological conditions. Moreover, transmission is not uniformly distributed in each camp. People living closer to the stagnant water of mosquito development sites are more likely to be bitten than those living farther away.

Many mosquitos can transmit arboviruses (arthropod-borne viruses), the most dangerous of which belong to the families Togaviridae (Chikungunya, O'Nyong-Nyong, Sindbis, Semliki) and Flaviviridae (yellow fever virus, den-

gue-fever virus, West Nile). Most arboviral infections affect only animals, some are occasionally transmitted from animals to humans, and the dengue-fever virus seems to affect only humans.

Mosquitos can also transmit filariasis, of which the most widespread in East Africa is Bancroft's filariasis (caused by *Wuchereria bancrofti*). In contrast to malaria - in which a single bite can cause the disease - filariasis can develop only after multiple bites.

#### **4.4. Hygiene measures and health education**

Although environmental measures play an important role in the malaria-prevention programmes, it is often difficult to apply them in the camps when the swampy zones, the paddy fields and irrigated plantations where the mosquitos reproduce are very widespread. It will be necessary to map the larval breeding sites in the vicinity of the camps in order to evaluate their size and the feasibility of taking measures.

Environmental changes such as the clearing of weeds around the shelters should be undertaken in order to reduce opportunities for the mosquitos to find resting places. Nevertheless, the impact of this type of action is minimal unless it is combined with other control measures.

Water-filled toilets are an excellent environment for the development of *Culex* larvae. To stop rain water from flowing into toilets, build up the edges of the pit with soil or other material until it is higher than the surrounding ground. If there is water in the pit, do not apply insecticides because they may prevent the faeces from decomposing. Do not pour used motor oil on the surface of the water because of the risk of pollution. Polystyrene pellets can be floated on the surface of the water to suffocate existing larvae and prevent adult mosquitos from laying eggs there. These pellets are supplied in bags, and expand 15-20 times their original size when heated in boiling water.

#### **4.5. Chemical control**

Controlling mosquitos is a complex problem that cannot be solved by insecticides alone. In fact, mosquitos cannot be entirely eradicated and the results obtained by chemical means can be only temporary. That means that mosquito era-

dication has therefore to be part of an integrated strategy, the basic activity of which is the physical elimination of the larval breeding sites.

Chemical control methods vary according to species of mosquito. The following subsections apply to the *Anopheles* vectors of malaria.

#### **4.5.1. Larvicides**

Existing mosquitos are best controlled during their larval stage for several reasons: larvae are easily targeted because they are not mobile; they are confined to sites containing water, and must stay in those sites for a considerable time. Therefore, they can be treated at any time of day, over an extended period. Also, great numbers of larvae are often concentrated in small, well-defined areas, allowing control personnel to achieve maximal results while using minimal effort, time, and materials. Another advantage of larviciding is that its effects generally last longer than adulticiding: after larvicides are applied, it takes one to two weeks for subsequent newly-hatched larvae to complete their development, whereas adulticide applications may need to be repeated within as little as 24 hours, due to immigration of adults from the surrounding area.

For these reasons, larviciding should be the main focus of any pesticide-based mosquito control programme, with adulticides being applied only in isolated cases of heavy infestation, or during epidemics.

#### ***Targets***

All development sites containing mosquito larvae must be treated. Larvae are rarely found in water deeper than 1 metre; thus, treatment can be confined to shallow sites. In large bodies of water, treatment of a 2-metre-wide strip along the shoreline is usually sufficient.

#### ***Insecticides***

The organophosphate malathion has been widely used in the control of larval mosquitos. However, malathion is highly toxic to fish, and preference must be given to larvicides such as temephos (Abate), and methoprene (Altosid), which are less harmful to non-target aquatic organisms. When temephos is applied to water, it forms a thin film over the surface which blocks the oxygen supply to mosquito larvae, effectively suffocating them. Methoprene acts as a larval growth regulator: larvae continue to grow, but die before reaching adulthood.

Very effective and extremely selective action - with no risk to the environment - can be obtained from the bacterial larvicides *Bacillus sphaericus* and *Bacillus thuringiensis* var. *israelensis* (also called *B.t.* serotype H-14, or *B.t.i.*). *Bacillus sphaericus* is recognised as most effective against *Culex* species in dirty or polluted water, whereas *B.t.i.* is effective against all types of mosquitos in many development habitats. In granular form, these larvicides have a short persistence (1-2 days), but in slow-release briquet form (a hard, round disk), they remain active for up to thirty days.

Certain petroleum derivatives have been prepared for use as larvicides, but their high cost, their weak persistence and environmental pollution problems limit their use.

If insecticides are applied to water used for drinking, they must not be toxic to humans. *B.t.i.* is non-toxic to humans, even at very high doses. Other choices are limited to temephos, methoprene, and diflubenzuron (another growth regulator) in doses not exceeding 1 mg of active ingredient (a.i.) per litre.

Table 1 shows the characteristics of insecticides suitable in refugee camps as larvicides in mosquito control.

**Table 1 - Insecticides suitable as larvicides in mosquito control**

Insecticide	Type	Dose a.i.	Oral toxicity for rats (LD <sub>50</sub> mg/kg body weight)
temephos	OP	56-112 g/ha	8600
temephos	OP	1-2 mg/l drinking water	8600
chlorpyrifos	OP	11-25 g/ha	135
diflubenzuron	GR	25-100 g/ha	4640
diflubenzuron	GR	1-2 mg/l drinking water	4640
<i>B.thuringiensis</i>	BI	0.6-2.4 litres/ha	absent
<i>B.thuringiensis</i>	BI	2.5-20 kg/ha	absent

a.i. = active ingredient ; LD = lethal dose; OP = organophosphate; GR = Growth regulator; BI = biological insecticide

### ***Application methods***

Larvicides are commonly available in two types of formulation: emulsifiable concentrates (EC), and granules. EC formulations are applied using pressure pumps (or motor pumps, in sites which are difficult to access). Granules can be

applied by hand, or with power-operated granule applicators. Granules are superior to emulsifiable concentrates in several ways: they do not require mixing, are safer to handle, easier to apply, less subject to being blown by the wind during application, and are better able to penetrate through aquatic vegetation to the water surface.

### ***Frequency of treatment***

The persistence of larvicides depends on the type of product used, and the quality of the treated water. Higher doses are necessary for polluted waters. With *Bacillus* granules, one treatment a week is necessary to ensure sufficient control, whereas temephos granules need only be applied every two weeks. *B.t.i.* briquets retain their effectiveness for up to thirty days, and slow-release methoprene briquets can last more than four months.

#### **4.5.2. Adulticides with a residual effect**

Indoor adulticiding is necessary when mosquito numbers are high and/or the risk of malaria transmission is great. Pesticides with residual contact activity are preferred because they retain their killing power for some time after application. Treatment must be carried out before the beginning of malaria transmission in cases of seasonal transmission, and periodically in cases of continuous transmission.

### ***Targets***

All houses and shelters in the area should be treated, beginning with the dwellings closest to larval development sites. Treatment of this high-risk zone helps to prevent mosquitos from penetrating to dwellings beyond it.

Observations inside the “blindés” have shown that mosquitos shun the plastic sheet surfaces, preferring to settle on the short walls and dividing partitions that are usually made of plaited straw. Therefore, treat the straw surfaces first, and when pesticide quantities are low, limit treatment to these surfaces only.

### ***Insecticides***

Pyrethroids such as deltamethrin and permethrin, or organophosphates such as malathion and fenitrothion, are best suited for treating the places where mosquitos settle.



Table 2 shows the characteristics of insecticides suitable in refugee camps as adulticides in mosquito control.

**Table 2 - Insecticides suitable as residual spray applications against mosquito vectors**

Insecticide	Type	Persistence (months)	Dose: g of a.i. per m <sup>2</sup>	Oral toxicity for rats (LD <sub>50</sub> mg/kg body weight)
deltamethrin	PY	4-6	0.05	>2940 (d)
permethrin	PY	2-3	0.5	>4000 (d)
lambda-cyhalothrin	PY	4-6	0.025-0.03	>2000 (d)
pirimiphos-methyl	OP	2-3	1-2	2018
malathion	OP	2-3	2	2100
fenitrothion	OP	3-4	1-2	503

a.i. = active ingredient ; LD = lethal dose; PY = pyrethroid; OP = organophosphate; (d) = dermal toxicity

Pyrethroids have better persistence on some surfaces (wood, plastic, vegetable matter) than others (mud, brick, concrete block, cement). Surfaces which are treated repeatedly acquire a greater killing capacity.

### *Application methods*

Two formulations are commonly available: emulsifiable concentrates, or wettable powders, both requiring dilution before application. These formulations are applied using pre-set, pressurised hand sprayers in such a way as to obtain uniform surface coverage, at a rate of 40 ml of solution per m<sup>2</sup> (pl. 7).

When applying these formulations, avoid contaminating food and drinking water. Do not spray eating or cooking areas, animals, or the surfaces they might lick.

### *Frequency of treatment*

The persistence of pyrethroid treatments depends on the formulation of the product, type of surface treated (absorption rates), temperature, humidity, and exposure of the surfaces to rain and sun. The residual effect of the insecticide on the different surfaces (plastic, clay, wood, straw) should be checked periodically by biological tests. Typically, treatment is necessary every two or three months. If this is not possible, at least one treatment per year must be done to cover the period of maximum malaria transmission.

#### **4.6. Mosquito nets and curtains impregnated with insecticides**

Field tests conducted in Africa have shown the effectiveness of mosquito nets, curtains, and other fabrics impregnated with insecticides in providing protection against mosquitos, and reducing the transmission of malaria (pl. 8). These items are particularly useful where vector control programmes are absent.

In refugee camps, the use of mosquito nets or insecticide-impregnated curtains could help to lower the incidence of malaria, and reduce the number of lice, ticks, houseflies, and other arthropods living in dwellings. Nevertheless, major obstacles (e.g. fixation problems, discrimination against local communities, high cost, and the risk of refugees reselling the nets on the local market) can make this remedy difficult to implement. In order for this plan to succeed, the entire community must become involved in its operation, and informed of the correct use of materials. Before proceeding with such a large-scale project, several trial tests should be run to see whether communities will accept mosquito nets, and use them effectively.

##### **4.6.1. Impregnated mosquito nets**

Three-dimensional rectangular nets are required, so as to completely enclose people in a "hollow box" as they sleep. Such nets are made of 100 denier-weight multi-strand nylon, and are available on the international market in four sizes: 70, 100, 130, or 190 cm wide X 180 cm long X 150 cm high.

Indelibly and consecutively numbering the nets helps in inventory control, and discourages their resale.

In zones of strong malaria endemicity, it is recommended that impregnated mosquito nets be systematically installed in hospitals and clinics.

##### **4.6.2. Impregnated curtains**

Impregnated curtains hung in dwellings have the advantage of being less costly than mosquito nets, easier to install, and better accepted by the people (pl. 9), but they are also less effective.

The better curtains are those made of cotton multistrand, with meshes of 0.5 cm.

### **4.6.3. Impregnated wall fabrics**

Cotton fabrics of a size suited to that of the dwellings (about 50% of the internal surface of the walls), and impregnated with 0.5 g/m<sup>2</sup> permethrin can be hung on the internal walls of houses to reduce mosquito population density. These fabrics must be washed and reimpregnated every six months. This method worked well in the camps of South-West Ethiopia where hut partitions are made of branches, making the spraying of homes with insecticides rather ineffective. On the other hand, this method is hard to picture in the “blindés” of the refugee camps.

### **4.6.4. Impregnation**

The directions for impregnating are the same for curtains, mosquito nets, and wall fabrics.

#### ***Insecticides***

Pyrethroids in emulsifiable concentrates are the insecticides of choice. Those most used are permethrin (at 500 mg/m<sup>2</sup>), and deltamethrin (at 25 mg/m<sup>2</sup>). Permethrin is less irritating to the skin and nose lining during handling.

#### ***Method of impregnation and installation***

Mosquito nets, curtains, and fabrics are impregnated either by soaking and wringing out, or by spraying.

The following equipment is necessary:

- pyrethroid insecticide in an emulsifiable concentrate;
- big plastic basins;
- measuring containers;
- rubber gloves;
- lines to hang the fabrics on after soaking;
- nails and wires for hanging the fabrics in place.

Proceed as follows:

(a) to calculate the quantity of water absorbed by the fabric:

- put a given quantity of water (decilitres or grams) in the basin;
- soak a given quantity of fabric (m<sup>2</sup>) in the water;
- let the fabric drain above the basin;
- measure the quantity of water remaining in the basin;
- subtract this quantity of water from the initial quantity to obtain the fabric absorption value.

(b) to impregnate:

- calculate the quantity of insecticide necessary for proper impregnation (see annex 8);
- dilute as required in the basin;
- soak and drain the fabrics above the basins taking care to use rubber gloves;
- hang the fabrics on lines to dry;
- once dry, distribute the mosquito nets/curtains with a sufficient quantity of nails and the wire necessary for hanging them.

Impregnation is quicker by spraying, but is less uniform and does not last as long.

### ***Frequency of re-impregnation***

Biological tests in Africa have shown that mosquito nets must be re-impregnated every six months, or more frequently if they are washed.

## 5. NON-BITING FLIES

### 5.1. Biology

The word “fly” is a general term which encompasses a large number of species from several families of the order Diptera. In refugee camps, non-biting flies of medical interest are the housefly (*Musca domestica*), the blowflies, and the fleshflies, all of which can passively transport pathogenic germs (i.e. they are mechanical vectors).

Eggs are laid (up to 2,000 a month, in the housefly) directly on organic matter, and hatch after about 24 hours into white larvae (maggots) which, after 3 development stages, become motionless brown pupae, from which the adults emerge. The cycle from egg to adult varies enormously according to temperature, from a minimum of 8 days at 35°C, to more than 45 days at 16°C. Development ceases below 13°C, and larvae die at a temperature of 45°C or more.

Larvae develop in various collections of organic matter, of human or vegetable origin. In refugee camps these are, in order of importance: open toilets (particularly for *Chrysomyia*), garbage and organic matter mixed with earth (particularly *Muscina* and *Musca*), stagnant water and human excrement (particularly for *Musca*), and decomposing meat and animal excrement (*Chrysomyia*, blowflies, and *Sarcophaga*, fleshflies; pl. 10). A kilogram or a litre of organic matter will support the development of from 5 to 10,000 flies.

Adult flies feed on sweet juices (pl. 13) and organic liquids, and have a lifespan of one to two months. In refugee camps, toilets with no lids on the defecation hole are good development sites for flies in the genus *Chrysomyia* (pl. 11). Fly traps set on the defecation hole can catch as many as 800 of these flies in a day (pl. 12). Unlike the housefly, the blowfly does not enter dwellings, but remains in the vicinity of garbage (pl. 14).

## **5.2. Collecting and sampling**

The type of treatment to be applied will depend on the species and number of flies present. Adult flies can be collected using butterfly nets or traps, and then identified. To estimate fly numbers, place a grill in a location where flies congregate, and count how many land on the grill during a 30-second period. Do at least three counts, and average the results. In order to compare results from different locations, all test conditions (i.e. type of site, time of day, weather) must be identical.

## **5.3. Diseases transmitted**

Flies pick up pathogenic germs on their feet, proboscis, and other body parts when they feed on organic liquids, or when they lay eggs on decomposing matter. They then carry these germs to the food on which they land (pl. 3). They can also regurgitate contaminated liquids onto food to dissolve solid foods such as sugar. Finally, their excrement containing germs can be deposited on eating and cooking utensils and food.

Flies of the *Musca* and *Chrysomyia* genera are often mechanical vectors of intestinal infections, such as dysentery, infantile diarrhoea, typhoid, and intestinal worms. They can also transmit poliomyelitis and certain skin or eye diseases, but are rarely involved in the transmission of cholera, as this disease requires massive quantities of contaminated matter. In unhygienic conditions, flies have many opportunities to transport pathogens mechanically.

## **5.4. Hygiene measures and health education**

Non-pesticide methods of fly control include:

- preventing fly access to toilets;
- eliminating potential development sites;
- protecting children, food, and food utensils from contact with flies.

### **5.4.1. Construction and maintenance of latrines**

Many refugee camps do not have enough toilets, and those that exist are often improperly used, and have no lid on the defecation hole - three conditions which contribute to the proliferation of flies.

When camps are set up, a sufficient number of latrines must be built (pl. 15-16). They should be situated at least 6 metres away from dwellings, and as far away as possible from health centres and eating areas. Latrines with ventilated improved pits are strongly recommended wherever construction of community toilets is planned (fig. 2; pl. 17).

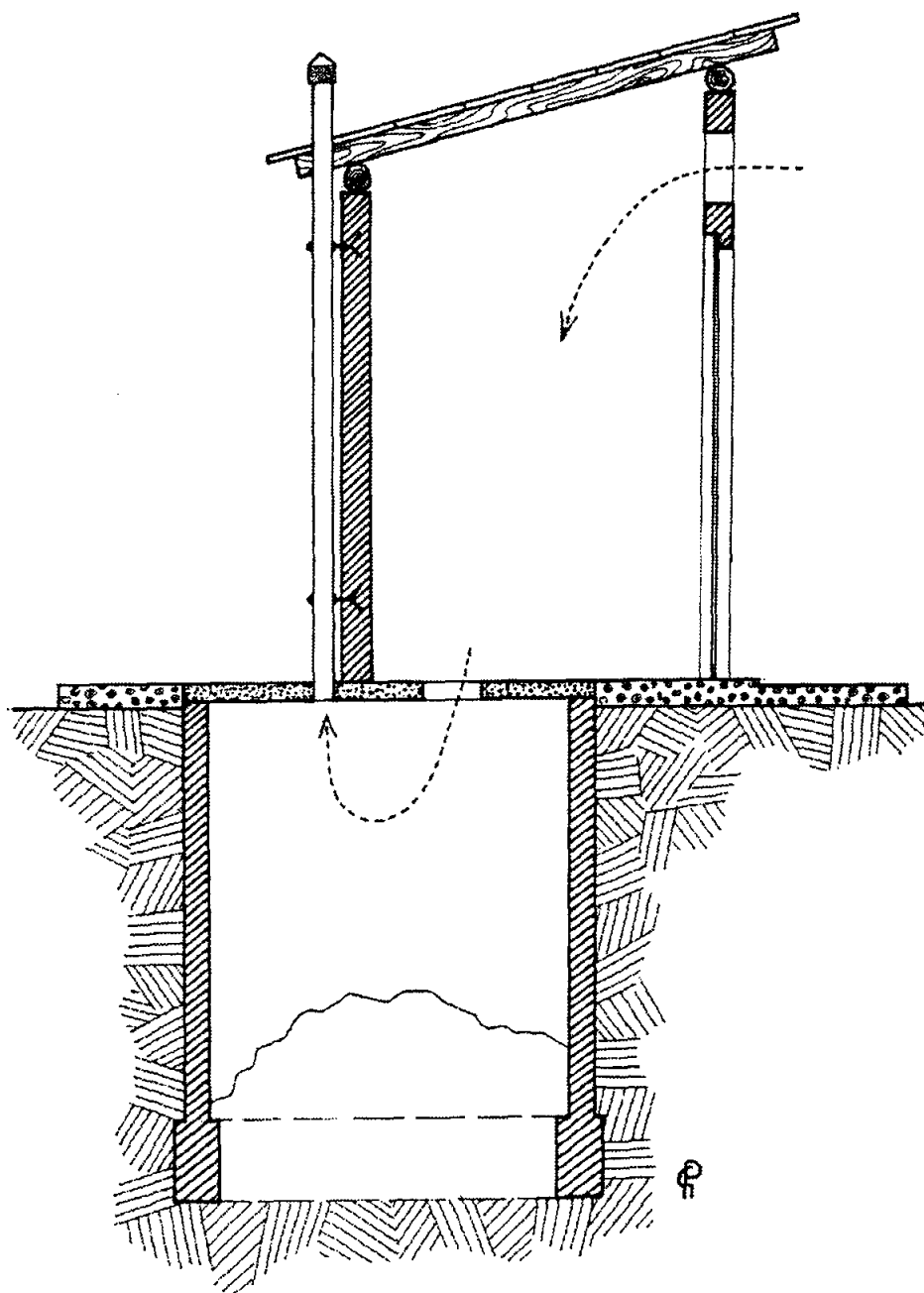
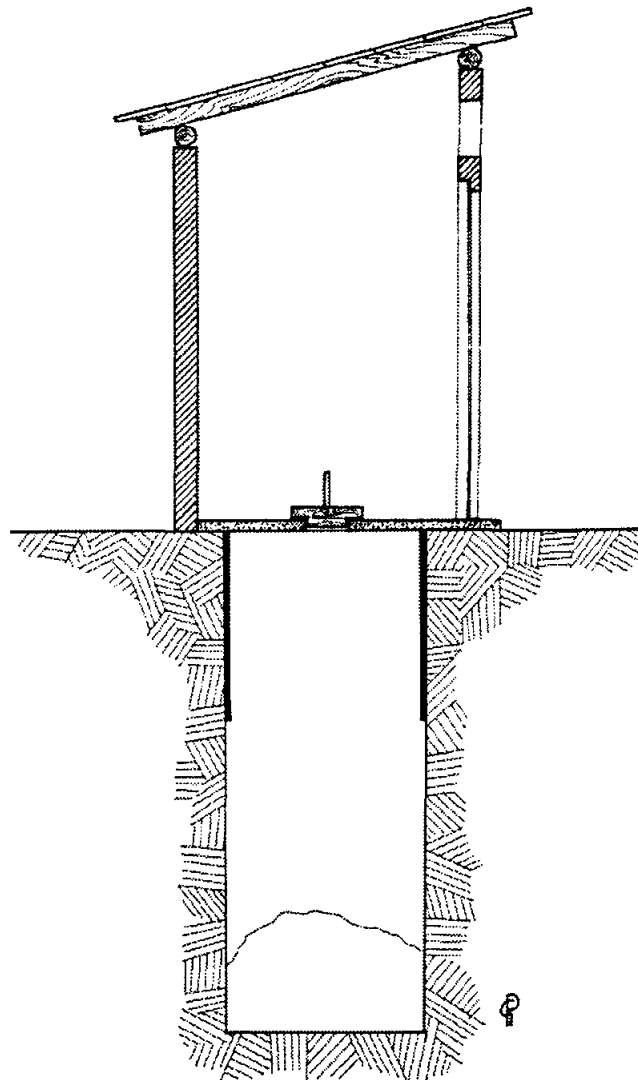

**Figure 2 - Diagram of a ventilated improved pit latrine**

Simple wooden lids should be made for all non-ventilated latrines. The lids should be made to fit into the defecation hole, closing it off completely (fig. 3).

They should be easy to operate with the foot, so as to avoid contaminating the hands with excrement.

An education campaign explaining the correct and routine use of the lids, and the proper and regular maintenance of the latrines must be carried out when latrine facilities are constructed.



**Figure 3 - Diagram of a pit latrine with a slab fitted with a lid**

#### **5.4.2. Management of domestic garbage**

Food waste attracts flies and rats. Dry waste, although less attractive to flies, provides shelter for arthropods and rats. Therefore, the collection and treatment of all waste is necessary in controlling transmissible diseases.



Large covered garbage bins should be provided, and cleaning and maintenance should be done at regular intervals. An adequate garbage collection service should also be organised. In tropical climates, garbage must be collected twice a week in order to limit the reproduction of flies.

Garbage disposal requires the construction of covered garbage pits. This involves excavating a large hole in the ground, and using the removed earth to cover up garbage dumped into the hole. The access of flies or other insects or animals to garbage will be minimal if the pits are operated according to the rules of sanitary landfilling (also known as “controlled dumping”), namely:

- the domestic garbage is covered by a 15 cm layer of earth, and then compacted;
- when the last layer of garbage is about 30 cm below the surface of the surrounding land, the pit is considered full, and must then be filled with earth, compacted, and a new pit must be dug nearby.

Garbage pits which are covered with a plastic sheet are not accessible to adult flies, and the fermentation temperature (over 47°C) is lethal to larvae already present in the garbage. Frequent turning of the garbage also helps to kill young larval stages of flies.

Hospital waste must be burned - never dumped with other garbage. It is mandatory that hospital waste be incinerated daily (pl. 18).

#### **5.4.3. Preventing access by flies**

Screens must be installed on the doors and windows of health centres, and cooking and eating areas. A mesh size of 12 holes per cm<sup>2</sup> prevents the entry of mosquitos as well as other flies.

Nylon or cotton curtains impregnated with pyrethroids and fitted to the doors of hospitals and health centres would provide additional protection; the curtains would be toxic to any insect landing on them.

#### **5.4.4. Using traps**

In health centres and where food is distributed, fly traps should be laid and kept active. The trap consists of a plastic receptacle containing fly bait, and a funnel-

like structure which allows flies to enter but prevents their escape (pl. 19). Traps can be made on the spot by cutting off the upper third of a plastic bottle, and placing it upside down on the lower two-thirds (fig. 4). Ripe mango waste and fish flour mixed with water make excellent baits. The traps are suspended 1.5-2 metres above the ground, at a minimum distance of 5 metres from larval development sites and 15 metres from protected places (hospitals, eating areas). Traps become active in 2-4 days and last 2-4 weeks, after which the bait must be replaced.

Do not use poison baits in refugee camps.

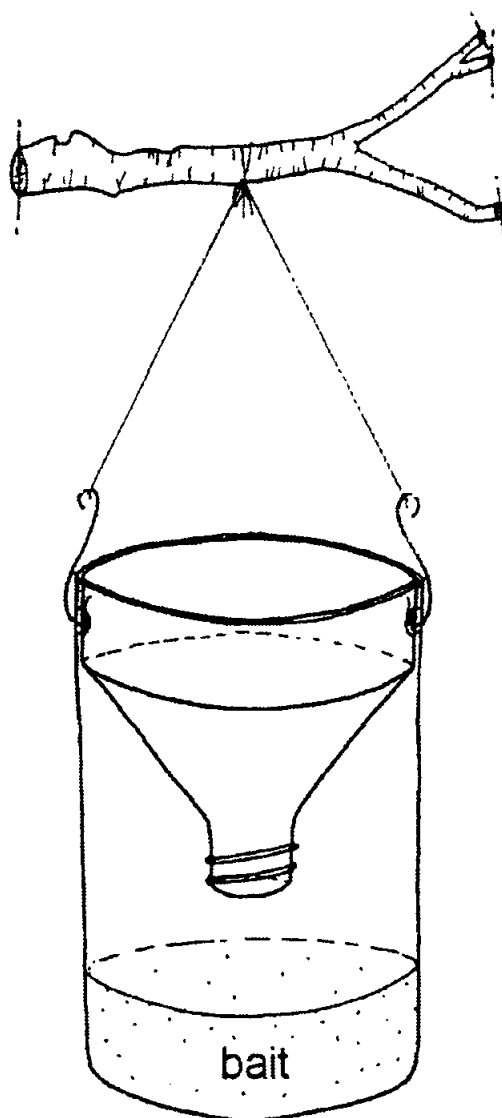

**Figure 4 - Diagram of a fly trap made from a plastic bottle**

### **5.4.5. Health Education**

Non-pesticide fly control requires community participation in the collection and removal of garbage.

It is essential that refugees understand the problem caused by the proliferation of flies, and that they actively participate in the following activities:

- cleaning the dwellings and the surrounding area;
- proper collection and elimination of garbage to prevent colonisation by flies;
- protection of food and food utensils from all contact by flies;
- correct use of toilets;
- keeping the floors, platforms, and vicinity of toilets clean.

Health education and information campaigns can be conducted using demonstrations, illustrated posters, and plays. Educational material adapted to local situations can be obtained through WHO and UNICEF offices, and from the relevant section of the Ministry of Health of the country involved.

## **5.5. Chemical control**

Sanitation is fundamental to the long-term control of flies. Insecticides are to be used not as a matter of course, but as a supplement to sanitary measures, in urgent situations only.

Flies can very quickly become resistant to insecticides, and insecticides applied to toilets may prevent the decomposition of faeces. For these reasons, larvicides should not be used for extended periods in latrines, and should not be used at all if sanitation measures have not also been implemented.

### **5.5.1. Treatments with residual effects**

The active ingredient in insecticides having residual effect is absorbed through the feet of flies when they land on a treated surface. In the evenings and on cloudy days, *Chrysomyia* flies prefer to rest outside dwellings, on surfaces near latrines or garbage pits, whereas houseflies often remain inside dwellings. Favourite resting places can be identified by the presence of spots of fly excrement.

#### ***Targets***

Latrines and garbage dumps must be treated to control adult flies. The treatment

of a latrine must include the walls of the superstructure, the platform, and the inner walls of the pit where newly-emerged flies often settle. The edges of garbage pits and the land surrounding them must also be treated.

Care must be taken to avoid contamination of foods and drinking water. Do not spray eating areas, kitchens, animals, or the surfaces they might lick.

### *Insecticides*

Residual pyrethroids should not be used by themselves because they can quickly cause resistance in flies which are already resistant to organochlorines such as DDT. Therefore, pyrethroid treatments must be alternated with organophosphates such as pirimiphos-methyl or malathion every six months.

Table 3 shows the characteristics of insecticides suitable in refugee camps for residual treatment in fly control.

**Table 3 - Insecticides suitable as residual treatment in fly control.**

Insecticide	Type	Dilution for use: g/l	Dose: g of a.i. per m <sup>2</sup>	Toxicity for rats (LD <sub>50</sub> mg/kg body weight)
malathion	OP	50	1-2	2100
pirimiphos-methyl	OP	12.5-25	1-2	2028
deltamethrin	PY	0.15-0.30	0.0075-0.15	>2940 <sup>(d)</sup>
permethrin	PY	0.62-1.25	0.025-0.05	>4000 <sup>(d)</sup>

LD = lethal dose; OP = organophosphate; PY = pyrethroid; <sup>(d)</sup> = dermal toxicity

### *Application methods*

Use pre-set pressure hand sprays to obtain an even flow. Smooth and non-absorbent surfaces such as plastic sheeting must be sprayed at a rate of 40-80 ml solution/ m<sup>2</sup>, whereas highly absorbent surfaces such as bricks or garbage require 250 ml/m<sup>2</sup>.

### *Frequency of treatment*

Garbage pits must be treated weekly. Latrines must be treated every two months during the rainy season, and every three months during the dry season. Pesticide persistence on walls (plastic sheeting) should be checked periodically by biological tests, and treatment frequency adjusted as necessary.

### **5.5.2. Direct contact spraying**

Direct spraying of adult flies on the wing or at rest is known as “space treatment”. It can quickly reduce the number of flies, and help to prevent their spread to new development sites created by the dumping and build-up of garbage in pits.

#### ***Targets***

Piles of garbage must be sprayed as soon as they are dumped, especially in the vicinity of markets.

#### ***Insecticides***

For space treatment, the insecticides of choice are deltamethrin at a dilution of 0.05 g/l (0.005%), permethrin 0.5 g/l (0.05%), pirimiphos-methyl 20 g/l (2%), or malathion 50 g/l (5%).

#### ***Application methods***

Space treatment is done with motorised backpack mistblowers, using an aqueous solution of insecticide that will be finely atomised. The droplets either hit the flies directly (killing them on contact), or coat the sprayed surfaces, creating a brief residual effect which will kill any flies that land or hatch there.

#### ***Frequency of treatments***

This treatment has only a short-term effect. To reduce the overall fly population, treatments must be done every day for two weeks, followed by weekly spraying. In market-places, direct spraying must be carried out after closing time.

### **5.5.3. Larviciding**

The statements made in section 5.5. bear repeating here: “Sanitation is fundamental to the long-term control of flies”. Insecticides are to be used not as a matter of course, but as a supplement to sanitary measures, in urgent situations only. Larvicides should not be used for extended periods in latrines, and should not be used at all if sanitation measures have not also been implemented.

As already mentioned regarding garbage dumps, the access of flies to garbage will be minimal if the pits are operated according to the rules of sanitary landfilling (or “controlled dumping”). Additionally, if the garbage pits are covered with

a plastic sheet, they will not be accessible to adult flies, and the fermentation temperature (over 47°C) will be lethal to larvae already present in the garbage.

In urgent situations of heavy infestation, larviciding may be required.

### ***Targets***

The chemical treatment of larvae must be done in latrines and garbage pits.

### ***Insecticides***

The most appropriate chemicals are pirimiphos-methyl and malathion. They must be used at the rate of 2.5-25 g of a.i. per litre of solution. Larval development sites are then sprayed with 0.5-5 litres of the solution according to the absorption capacity of the site. These insecticides can also be used in powder form. Growth regulators such as diflubenzuron may be used at the rate of 0.5-1 g of a.i. per m<sup>2</sup>.

### ***Frequency of treatment***

Latrine and garbage pits must be treated weekly.

## **5.6. Biological control**

Formulations of a biological larvicide (*Bacillus thuringiensis*, strain H-1) were recently developed for use in refugee camps. Larvae which eat the bacillus are killed by the toxin it releases. The larvicide is not harmful to humans or the environment, and has been shown to have a long residual effect under certain conditions. However, in over-populated refugee camps where faecal matter rapidly accumulates in the latrine pits, this larvicide was only partially effective. The formulation currently marketed must be applied in doses of 25 ml per m<sup>2</sup> of faecal matter.

## 6. LICE

### 6.1. Biology

There are three species of human lice: head louse (*Pediculus capitis*, pl. 20), body louse (*Pediculus humanus*, pl. 21), and pubic louse (*Phthirus pubis*, pl. 22), also called crab louse. The biology of the three species is similar. They all feed on blood, live on a single host species (humans), and have three development stages: egg, nymph (with three moults), and adult.

Only the body louse is a vector of disease, and, therefore, a potential danger in refugee camps. It is 2-3 mm long and 1-1.5 mm wide. The females lay about 300 eggs, at the rate of about 10 eggs daily, on clothing next to the skin. Body lice live in the folds of clothing, and only come in contact with the skin long enough to take a blood meal. The adults die after two days if they are not in contact with the host, whereas the eggs can survive up to a week. They spread from host to host via direct contact with skin, clothing, or bedding.

Body lice are common where personal hygiene measures such as washing and changing clothes are not practised. All ages of people may be infested.

### 6.2. Diseases transmitted

Body lice bites can cause skin irritations. Scratching of the affected areas may lead to dermatitis, impetigo, or other diseases caused by staphylococci that infect the lesions. In East Africa, body lice can be vectors of “epidemic typhus” (due to *Rickettsia prowazeki*) and “relapsing fever” (due to *Borrelia recurrentis*).

These diseases are not transmitted by the bite of the louse. Epidemic typhus is transmitted by the louse’s contaminated faeces which penetrate the skin when it is scratched. The micro-organisms remain alive in the dry stools for up to three months, and may be transferred from the hands to the eyes, infecting subjects through the lining of the eyelid. It is a highly contagious disease even for those carrying no parasites, and care must be taken when handling underclothing or

bedding of patients affected by typhus. Relapsing fever, on the other hand, is transmitted only by lice crushed on the skin when scratching, and it affects only people who carry the parasite.

Relapsing fever occurs in Ethiopia, Somalia, Sudan and Burundi, while typhus is endemic in the mountainous regions of East and Central Africa. Refugee camps in East Africa typically contain a large number of people living in unclean and crowded conditions. When a high percentage of the population are lice carriers, a typhus epidemic can break out at any time. In case of occurrence of “fevers of unknown origin” unaffected by anti-malaria treatment, but which respond to tetracycline or chloramphenicol, typhus can be suspected.

### **6.3. Hygiene measures and health education**

Soap and cold water will not remove body lice from clothing. Clothes must be washed in very hot water ( $> 60^{\circ}\text{C}$ ), or be exposed to hot air ( $> 70^{\circ}\text{C}$ ) for an hour. To ensure that lice eggs are also eliminated, clothing and bed linen must be boiled or steamed for 15 minutes.

### **6.4. Chemical control**

The use of insecticides is the only means of rapidly reducing lice infestation and thus preventing the transmission of disease in the community.

#### ***Targets***

When typhus is epidemic, the entire community must immediately be treated with insecticide powder. It is advisable to subject all newly-arrived refugees to deparasiting treatment, and to perform periodic delousing treatment in schools.

#### ***Insecticides***

Given that several strains of body lice in East Africa have become resistant to DDT and organophosphates, the most suitable chemicals for current use are carbamates and pyrethroids. These insecticides are marketed in powder form (permethrin in a 0.5% concentration, deltamethrin in a 0.03% concentration, or propoxur in a 1% concentration, applied at 125-250 g per  $\text{m}^2$  of fabric). Note that these powders are totally different from wettable powders (WP); wettable powders should never be used to treat clothing and bed linen.

#### ***Application methods***

Powder is the best insecticide formulation for mass delousing. It can easily be



applied with either hand or motor-driven dusters. The treatment consists in uniformly applying about 50 g of product for adults and 25 g for children on the entire inside surface of all clothing that is in direct contact with the skin. The powder must be applied around the collar, the sleeves, the waistband of trousers and, in particular, in underclothing. Clothing not worn must also be treated. As the powder leaves traces on the clothing, it is easy to see which persons have been treated. To maximise participation in mass treatments, care must be taken to respect the sensibilities of all individuals involved, especially those of the opposite sex.

The insecticide must never come into contact with the eyes. The powder can provoke contact dermatitis in some individuals.

### ***Equipment and materials***

Hand dusters can be made from bags of loose-weave fabrics suspended on a stick, or by punching holes in the lid of empty food cans. A worker with a hand duster can visit about 150 “blindés” a day (fig. 5). For large-scale operations, hand or motorised pump-operated dusters are preferable.

About 4 tons of permethrin powder form at 0.5% are necessary to treat 100,000 refugees.

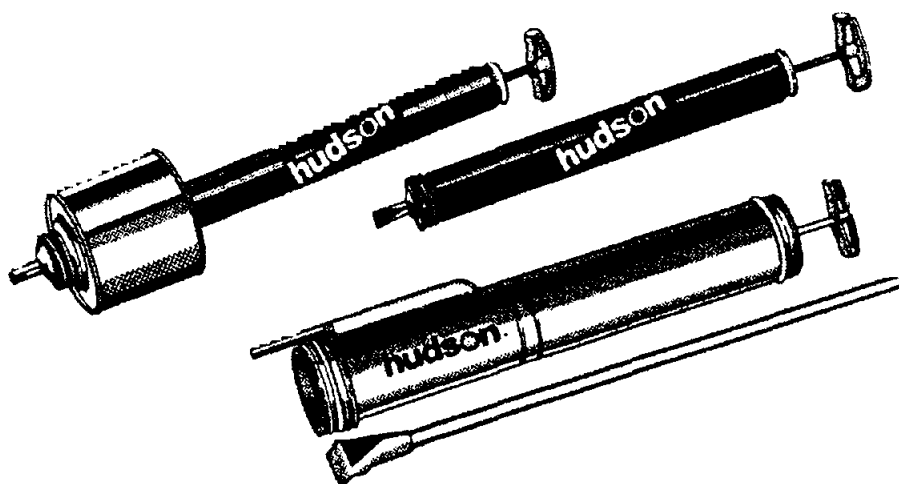

**Figure 5 - Hand-operated dusters**

(Reproduced with the permission of the H.D. Manufacturing Company, Chicago, Illinois 60611 USA)

### *Frequency of treatment*

Careful treatment of clothing with insecticide is normally sufficient to reduce the infestation, particularly if a mosquito spraying campaign is carried out in dwellings at the same time. Lice eggs are often unaffected by this treatment, so it is best to treat again a week later to kill the newly-hatched lice.

## 7. FLEAS

### 7.1. Biology

Fleas are insects whose bodies are very flattened laterally and whose highly developed rear legs enable them to jump 10 cm in height and 15 cm in distance. Their mouthparts are adapted to sucking the blood of mammals and birds. Fleas have four development stages: egg, larva, pupa, and adult. The eggs are laid in the host's bedding and on the floor of dwellings. The worm-like larva feeds on various debris from the host. A flea can live from one to four months without feeding, but can survive for up to 17 months if it takes regular blood meals.

The two most important species from a medical viewpoint are the rat flea (*Xenopsylla cheopis*) and the human flea (*Pulex irritans*, pl. 23). In refugee camps above 1,400 metres altitude, only the human flea is a problem. It seldom remains on humans after biting, preferring to live in the bedding, or in cavities in the ground. *Pulex irritans* also parasitises several other mammals. A third species, the jigger flea (*Tunga penetrans*), is a human parasite. The female usually lives in the skin of the feet and the hands but lays eggs outside.

### 7.2. Collecting and sampling

Rodent fleas can be collected once the rodents have been captured, killed, and placed in plastic bags. The fleas leave the dead animals and can then be caught, identified, and counted, to determine the percentage of rodents carrying parasites and the average number of fleas per host.

Human fleas can be captured by hand from bedding laid on the ground in direct sunlight. Considering the risk of disease in refugee camps, the use of mouth-operated sucking tubes (aspirators) is not advised. The use of light and carbon dioxide traps may be considered in special situations.

Captured specimens must be preserved in 70% alcohol for species identification, and in a 3% saline solution for bacteriological research.

### **7.3. Diseases transmitted**

Fleas can transmit several diseases to humans, the most serious being the plague. In the west of Zaire and in Tanzania, it is endemic, but there are no epidemic foci in the mountainous regions.

Fleas can also carry *Rickettsia mooseri*, the agent responsible for murine typhus, frequent among rodents and also occasionally affecting humans. Contamination is caused by germs in the fleas' excrement penetrating the skin when the hosts scratch themselves. Given its feeding habits, the human flea is a less dangerous vector of disease than the rat flea.

Flea bites are a considerable nuisance that can cause insomnia and nervous disorders. Lesions caused by scratching can become infected and cause dermatitis (pl. 24). The jigger flea causes intense skin irritation, ulcers, and sometimes abscesses.

### **7.4. Hygiene measures and health education**

To reduce levels of flea infestation, bedding must be taken out of the dwellings at least once a week and exposed to the sun. The dwellings must be swept regularly and cleaned as carefully as possible. If infestations are particularly heavy, it may be necessary to resort to insecticide treatment.

### **7.5. Chemical control**

If the camps are situated in a zone where the plague is endemic, it is essential that a rat eradication campaign be run in tandem with the antiparasite treatment. Conversely, if there is an outbreak of the plague, rat poison should not be used, but only insecticides to kill fleas before they have the opportunity to leave dead rats and transmit the disease to humans.

In refugee camps where the risk of transmitting the plague is minimal, control is aimed at reducing the nuisance caused by flea bites. This will also reduce the risk of transmitting rickettsioses.

### ***Targets***

Bedding and floors must be treated. If liquid insecticides are used, the treatment must be applied early in the morning on sunny days to allow the bedding to dry before night.

Food and water supplies must be taken out of the dwellings before spraying, and not returned for at least an hour after spraying. Children's bedding must not be treated directly but only exposed to the vapours released when the dwellings are being treated.

### ***Insecticides***

The human flea is very sensitive to pyrethroids. Deltamethrin seems to be the most appropriate insecticide for controlling this insect, whereas permethrin could be reserved for controlling body lice.

### ***Application methods***

The application of liquid formulations (EC's) is more practical for large-scale operations, although powders are equally effective. Deltamethrin must be used in concentrations of 0.05 g of a.i./litre (0.005%), and permethrin at 1.25 g/l (0.125%). Hand compression sprayers are used in the application.

### ***Frequency of treatment***

Insecticide treatment, combined with hygiene measures, are effective for up to six months.

## 8. BED BUGS

### 8.1. Biology

Bed bugs are brownish insects with a flat, oval body, about 7 mm long. They have three development stages: egg, nymph (with five moults), and adult. The mouthparts of nymphs and adults are adapted for sucking, and they fold back under the body when not in use.

The two species of bed bugs most frequently found as human parasites are *Cimex lectularius* (pl. 25), which lives mostly in temperate zones, and *C.hemipterus*, which lives exclusively in tropical zones. Both species have been reported in the higher regions of East Africa.

### 8.2. Collecting and sampling

Nymphs and adults live in swarms in dark shelters, from which they emerge at night to feed on humans and animals.

The presence of these insects can be detected by their typical odour and by their excrement. It is easy to dislodge them during the day by spraying with a pyrethroid.

### 8.3. Medical importance

Although bugs may occasionally contain parasites and pathogenic germs, there are no records of them transmitting diseases to humans in Africa. They are therefore nothing but a nuisance in refugee camps. Colonisation of dwellings by these insects is slow, and infestation is a problem only in camps that have existed for several months or more. Bed bugs consume such large quantities of blood (from two to six times their own weight) that in heavily infested places, young children can show signs of anaemia. Bug bites cause swelling, redness, and itchiness.

#### **8.4. Control**

Bug control measures are rarely necessary in refugee camps. Cleanliness of dwellings and their occupants helps to prevent bug infestation, and indoor spraying of insecticides to kill mosquitos will be effective against bed bugs as well.

The following insecticides can be used for specifically controlling bed bugs: deltamethrin at a concentration of 0.05 g per litre (0.005%), permethrin at 10 g/l (1%), pirimiphos-methyl at 10 g/l (1%) and natural pyrethrins at 1-2 g/l (0.1-0.2%).

## 9. HUMAN SCABIES MITES

### 9.1. Biology

Human scabies mites (*Sarcoptes scabiei* var. *hominis*) are fairly common in refugee camps. They are tiny oval-shaped parasites with a maximum diameter of 0.5 mm (fig. 6). The female burrows beneath the top layer of the skin to lay two to three eggs a day, over about 20 days. The larvae live on the surface of the skin where they dig small craters in which they shelter. The complete cycle of the parasite takes about 30 days. After mating, which takes place on the skin, the male dies and the female waits for the eggs to mature before beginning to dig burrows in which to lay them.

Scabies mites are active only at temperatures of 20°C or more, and transmission takes place principally by direct contact, more rarely through the exchange of clothing and bedding. They can survive no more than two days away from humans. Scabies mites feed on lymph they find in the skin; they do not suck blood.

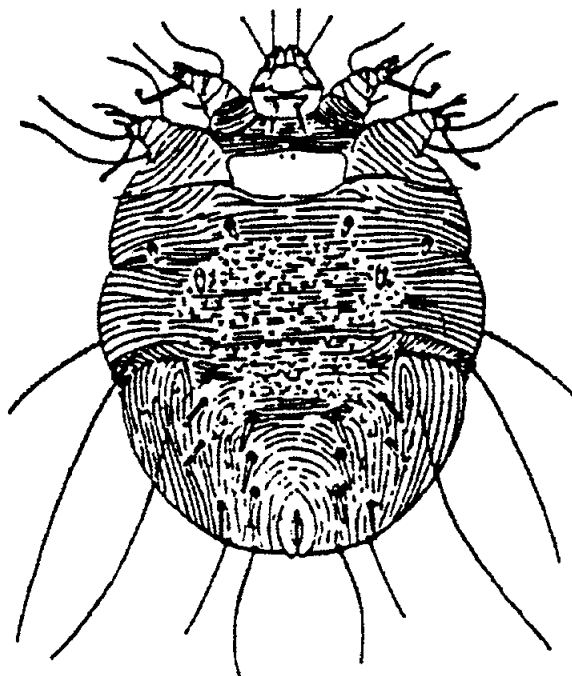

**Figure 6 - Human scabies mites (*Sarcoptes scabiei* var. *hominis*)**



## **9.2. Detection**

Diagnosis of scabies is virtually impossible before the itching starts about three weeks after infestation. To confirm the diagnosis, the mites can be looked for by spreading mineral oil on the affected skin, then scratching it with a scalpel blade. The collected material must be transferred to a glass slide and covered with another before being viewed under a microscope.

## **9.3. Human scabies**

Human scabies is due to the direct action of *Sarcoptes scabiei* var. *hominis* embedded in the outer layer of the skin. The parts of the body most affected are those where the skin is the most tender (i.e. the webs between the fingers, the fold of the elbows, the front of the wrists, the armpits, and the waist). The irritation caused by scabies is principally of allergic origin. It manifests itself by a reddening of the affected part and by acute itching. The mites multiply over the next few months, up to a maximum of 500, but usually diminish to 10 in chronic infestations, due to the immune defences of the host.

The three characteristic clinical signs of scabies are: frequent night-time itching, presence on the skin of slightly raised winding burrows 3 to 15 mm long, and pearly pustules, especially between the fingers. The small lesions caused by scratching are an easy target for secondary bacterial infections. A form of scabies, known as “Norwegian”, is characterised by the presence of crusts without itching that can develop in immuno-deficient subjects (AIDS sufferers) or those with acute food deficiencies.

## **9.4. Hygiene measures and health education**

Poverty, lack of hygiene, and promiscuity, so frequent in refugee camps, are factors favourable to the propagation of scabies. Children are particularly affected.

A programme to improve personal hygiene among primary school children should be set up in refugee camps in co-operation with UNICEF. The installation of rain-water collection systems in schools could provide the water necessary to wash school children and their clothing.

When treating with acaricides, clothing can be boiled to eliminate any parasites.

## 9.5. Chemical control

Scabies mites can be eliminated by washing the damaged skin with soap and water and then rubbing down with the following products:

- a sulphur ointment at a concentration of 10% for adults and 2% for children, in paraffin;
- benzyl benzoate at a concentration of 25% in water;
- special formulations of permethrin (1.25 g of a.i. per litre).

The sulphur ointment treatment is best because it is cheap, effective, and harmless to children and pregnant women. Three applications are necessary for elimination of the parasites.

Treatment with benzyl benzoate is very effective but cannot be used on children or on men suffering from eczema of the scrotum. The entire body surface (except the face) must be treated before sleeping, and rinsed off 24 hours later. Clothing and bedding must be changed the next day. To be effective, the treatment must be applied to all the members of a family at the same time and be part of a large scale campaign in order to avoid the subjects becoming rapidly reinfested.

## 10. TICKS

### 10.1. Biology

Ticks - like scabies mites - are acarids, but they are much bigger (7-20 mm). There are two principal families of ticks: the Ixodidae, or “hard” ticks, so called for their hardened backs, and the Argasidae, or “soft” ticks, which have soft backs.

The biological cycle comprises four stages in the Ixodidae and five in the Argasidae. To pass from one stage to the next, the tick must take a blood meal. It can nevertheless survive long periods without food.

*Ornithodoros moubata* is the most common soft tick in East Africa. It lives on the floor of dwellings and frequently feeds on humans (fig. 7).

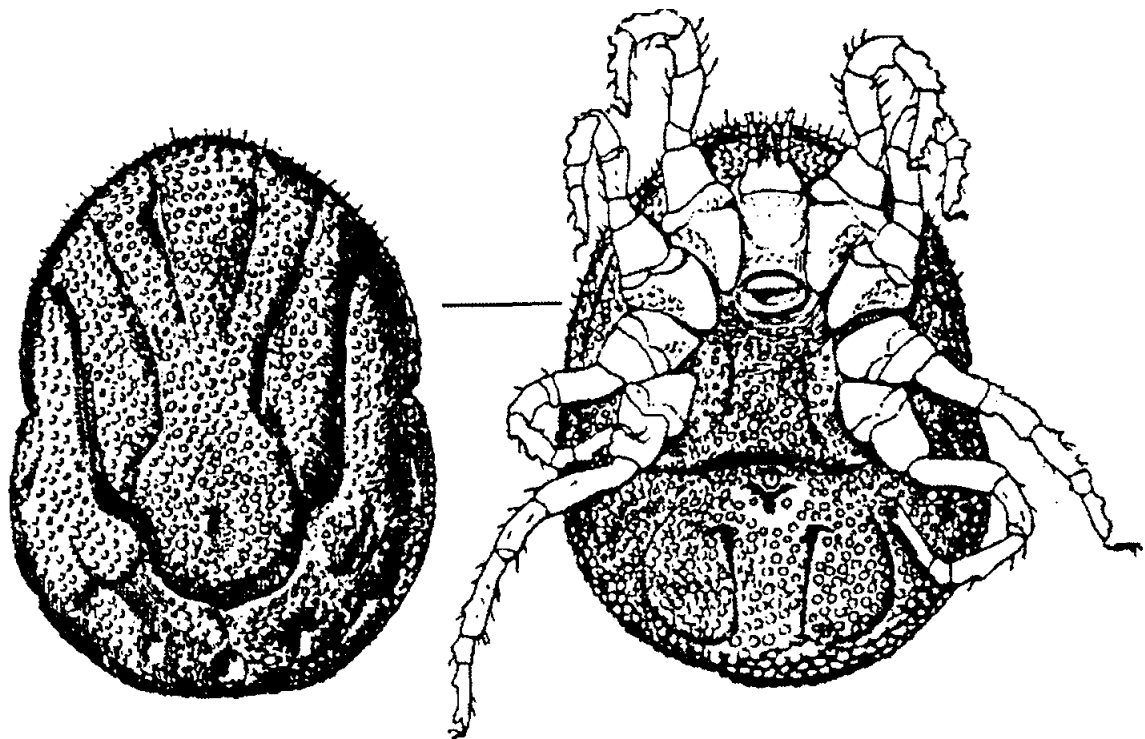

Figure 7 - The soft tick *Ornithodoros moubata*

## **10.2. Collecting and sampling**

When ticks are not on the host, they are in the host's resting place or in open spaces such as meadows. To collect them, sweep the vegetation with a piece of light-coloured fabric. Ticks which attach themselves to the fabric will be easily seen. Remove specimens using tweezers, and preserve them in 70% alcohol for later identification. Carbon dioxide traps can be used for special studies.

## **10.3. Diseases transmitted**

Ticks are vectors of several diseases, both in humans and animals. In East Africa, Ixodidae can transmit rickettsial diseases (including Q-fever), and arboviruses (such as the Crimean-Congo haemorrhage fever).

*Ornithodoros moubata* ticks can transmit the *Borrelia duttoni* spirochete that causes relapsing fever, endemic to East Africa.

## **10.4. Control**

Ticks are usually not a problem in refugee camps and it is not necessary to resort to specific control measures which are, moreover, difficult to apply.

To control *Ornithodoros* ticks inside dwellings, treat with Lindane at a concentration of 3 g of a.i. per m<sup>2</sup>; this is effective for a year.

## 11. OTHER ARTHROPODS OF MEDICAL IMPORTANCE

The following groups of arthropods are sometimes present in refugee camps in East Africa, but rarely require control.

### 11.1. Cockroaches

Cockroaches are flat insects 1-4 cm long, equipped with long threadlike antennae, and mouthparts adapted for chewing. Certain species with wings can fly long distances. The three most common species are *Blattella germanica*, *B. orientalis*, and *Periplaneta americana* (pl. 26).

Their life cycle includes the egg, nymph, and adult, and development is greatly influenced by temperature, relative humidity, and the availability of food. The eggs are carried in egg cases called "ootheca". These insects are gregarious.

Cockroaches can contaminate human food if it is not protected. They habitually regurgitate part of the food they eat, and often defecate while feeding. Cockroaches can harbour more than forty types of pathogenic bacteria inside their bodies, as well as several viruses, including poliomyelitis. They can also passively carry pathogenic amoebae and the eggs of intestinal worms to humans.

Food in refugee camp dwellings must be kept covered or in enclosed places (fine mesh) to avoid contamination by cockroaches. In cases of strong infestation or in places where such measures cannot be applied, the periodic use of organophosphates or pyrethroids with a residual effect can be resorted to. The products come in emulsifiable concentrates, in powder form, or in aerosols.

Table 4 shows the insecticides that can be used to control cockroaches in refugee camps.

**Table 4 - Insecticides commonly employed in the control of cockroaches**

Insecticide	Type	Formulation	Concentration g/l or g/kg	Oral toxicity for rats (LD <sub>50</sub> mg/kg body weight)
chlorpyrifos	OP	liquid	5	135
pirimiphos-methyl	OP	liquid	25	2018
pirimiphos-methyl	OP	powder	20	2018
malathion	OP	liquid	30	2100
malathion	OP	powder	50	2100
deltamethrin	PY	liquid	0.075	> 2940
deltamethrin	PY	powder	0.005	> 2940
deltamethrin	PY	aerosol	0,2	> 2940
permethrin	PY	liquid	1.25-2.5	> 4000
permethrin	PY	powder	5	> 4000

LD = lethal dose; OP = organophosphate; PY = pyrethroid

Treatments can be conducted using hand compression sprayers, using 4 litres of solution to spray a strip of surface 100 metres long by 30 to 50 centimetres wide. The places to be treated are often those where food is stored, so care must be taken to avoid the pesticide coming into contact with the food. The treatment must be repeated every month, in combination with normal and regular hygiene measures.

### 11.2. Tsetse-flies

Tsetse-flies (Diptera, Glossinidae, genus *Glossina*), are large (up to 16 mm) light brown flies, with a long proboscis and overlapping wings which are folded over the abdomen at rest. The larvae develop up to the third stage inside the uterus of the female. After about ten days, they are expelled, and then pupate. Different species of *Glossina* colonise different ecological zones. The most important species in East Africa belong to *morsitans*-group (pl. 10), found in the savannah, to *fusca*-group, found in dense and humid forests, and to *palpalis*-group, found near water bordering forests.

Both the males and the females are aggressive blood suckers and bite animals and sometimes humans during the day. They can transmit two subspecies of trypanosome, which are cattle and human parasites that complete their development

cycle in the fly: *Trypanosoma brucei rhodesiense* and *T.b.gambiense*. The symptoms of both infections (called “sleeping sickness”) are similar, but the disease is typically chronic in *T.b.gambiense* infections, whereas evolution is quicker in the *T.b.rhodesiense* infections. Refugees can be infected when crossing forest zones (for example, the Akagera region of Rwanda). Deforestation caused by a massive concentration of refugees often results in a thinning of the tsetse-fly population, but the reduced availability of wild animals also makes *Glossina* more aggressive towards humans.

In each East African country, there are national programmes and cross-border controls of sleeping sickness and animal trypanosomiasis. If necessary, operators of these programmes may be asked to include the zones surrounding refugee camps in their operations.

In these programmes, the use of fabric screens to attract and kill flies produces very good results, particularly with *G.morsitans*. These traps consist of 1 m<sup>2</sup> of black-and-blue-striped fabric impregnated with 100 mg of deltamethrin, and suspended vertically from a wooden frame (pl. 27). Four traps are placed per km<sup>2</sup>. Since the odour of acetone or zebu urine increases the trap’s attractive power, a test-tube full of urine can be placed in a pocket in the centre of the screen, and an open bottle of acetone can be buried at the base of the screen. Reimpregnating the fabrics every three months is sufficient, especially if they are made of nylon.

### **11.3. Sandflies**

Sandflies (Diptera, Psychodidae) are very small (2-3 mm) yellow two-winged flies whose body and wings are extremely hairy. They have four development stages: egg, larva, pupa, and adult. The larvae often develop in animal burrows and termite mounds.

The females are night-time blood suckers. In East Africa, the five most important species from a medical viewpoint are *Phlebotomus langeroni*, *P.orientalis*, *P.martini*, *P.longipes*, and *P.pedifer*. The first three are vectors of visceral leishmaniasis; the last two of cutaneous leishmaniasis. Sandflies can also transmit arbovirus.

In East Africa, visceral leishmaniasis is common throughout the very dry rural zones where acacias grow and where termite mounds are found. Camps should

not be set up less than a kilometre from these zones, and refugees should be told of the danger of visiting these places at dusk or at night.

Sandflies are often associated with specific rural habitats, so they are not normally a problem in refugee camps. In the case of the peridomestic sandfly, the treatment of dwellings against mosquitos is also very effective against these small insects.

#### **11.4. Blackflies**

Blackflies (Diptera, Simuliidae) are small, dark gnats (1-5 mm), of which only the females suck blood. The larvae develop in well oxygenated running water, attached to rocks or the leaves of aquatic plants. There are many known species which can only be identified by a specialist (entomologist). In Africa, two species are important vectors: *Simulium damnosum* (in the central and western part) and *S.neavei* (in the eastern part). Adult females are daytime biters, and can fly many kilometres away from larval development sites in search of a blood meal.

Although the bite of these insects is painful and causes acute irritation, the main concern with blackflies in Africa is that they are vectors of the microfilaria *Onchocerca volvulus*, which causes river blindness (onchocerciasis).

Control can be directed against the aquatic stages of blackflies, but the cost and logistics of the operation require that it be done as a separate and specific programme.

#### **11.5. Myiasigenic flies**

“Myiasis” means: the infestation of humans or animals by fly larvae. In some species of fly, larvae feed on the organs, tissues, and fluids of the host vertebrate. Some of the non-biting flies mentioned in preceding chapters may deposit eggs in wounds or sores, with the resulting larvae feeding on decaying tissue (facultative myiasis). In other species of fly, larvae can develop only on living tissues (obligatory myiasis). In tropical Africa, larvae of *Cordylobia anthropophaga* (called “Cayor worms”) are myiasigenic obligatory parasites. Their preferred host is the rat, but humans can also be infested.



Another fly larva, *Auchmeromyia luteola* (the “floor-maggot fly”), lives in the ground and feeds on the blood of people lying on the ground at night. It is found only in dwellings in tropical Africa.

Myiasis can be prevented by informing people how infestation occurs, cleaning body wounds and sores, and applying insecticide on the ground where fly eggs are laid.

### **11.6. Stablefly**

The stablefly (*Stomoxys calcitrans*) is very similar in appearance to the housefly but it lives almost exclusively in stables and around cattle, very rarely entering dwellings. Male and female adult flies have a bayonet-shaped mouthpart with which they bite and draw blood from cattle, and occasionally from humans during the day. The stablefly’s distinctive mouthpart easily distinguishes it from the housefly. Larvae develop in rotting straw, mown grass, and compost.

Stablefly numbers can be controlled by frequent turning of the organic matter in which larvae develop.

## 12. SNAILS HOSTS OF SCHISTOSOMES

### 12.1. Biology

In East Africa, several species of snails of the genera *Bulinus* and *Biomphalaria* serve as intermediate hosts for the development of flatworms, or blood flukes, of the family Schistosomatidae. This is the parasite which cause the human disease known as schistosomiasis.

Snails develop and live in the shallow, slow-moving or standing water of ponds, swamps, lakeshores, rivers, and irrigation canals. They live on aquatic vegetation, or sink into the mud to shelter from the currents (pl. 28). Water which is polluted with human sewage, is very favourable to proliferation of snails, and is frequently present around refugee camps.

### 12.2. Collecting and sampling

To determine the source and/or potential of schistosomiasis transmission, snails must be collected from the water around refugee camps. Using a large sieve on a long handle, sweep through the vegetation in the water, and scrape along the surface of the muddy bottom. Use tweezers to remove the collected snails, and preserve them in 4% formol for later identification. A standardised collection technique lasting 10 to 20 minutes, repeated several times, will give an estimate of snail population density. Always wear rubber gloves while collecting, to avoid skin contact with water that could contain the infectious form (cercaria).

### 12.3. Diseases transmitted

In Africa, there are two forms of schistosomiasis affecting humans: urinary schistosomiasis (caused by *Schistosoma hematobium*), and intestinal schistosomiasis (caused by *S.mansoni*). The intermediary snail hosts for transmitting urinary schistosomiasis are *Bulinus nasutus* and *B.globosus*, whereas for intestinal schistosomiasis, they are *Biomphalaria pfeifferi* and *B.sudanica*.

Adult schistosoma flukes live in the vessels of the mesenteric (*S.mansoni*) or the vessical plexuses (*S.hematobium*). The female lays about 300 eggs a day, and these are expelled either with the faeces (in intestinal schistosomiasis) or in the urine (in urinary schistosomiasis). Once the eggs reach water they hatch into first-stage larvae (miracidia) which penetrate aquatic snails. The miracidium divides in the snail, producing thousands of new parasites (cercariae) which are excreted by the snail into the surrounding water. They can penetrate the skin of humans bathing or swimming in the water. Once entering the human body the cercariae grow into long worms and they migrate to the appropriate blood vessels.

#### **12.4. Hygiene measures and health education**

Controlling schistosomiasis involves several aspects, the prime components of which are:

- mass treatment of cases;
- sanitation measures;
- health education;
- chemical control of the intermediate hosts.

In refugee camps, sanitation measures and health education are most important. The aims are to prevent human sewage from reaching stagnant waters, and to prevent cercariae in the water from coming into contact with human skin. To attain these goals in the zones where there is a risk of schistosomiasis, it is necessary to:

- increase the drinking-water supply systems (pl. 29);
- provide sanitary facilities;
- build showers and washing areas (pl. 30).

The construction of drainage systems helps eliminate or prevent the formation of habitats favourable to snails. In large accumulations of water, it is periodically necessary to cut water plants growing near the shore. Organic waste such as the trunks of banana trees must not be thrown into the water because they provide a very favourable substrate for their development.

Rivers can be canalised or concreted over for some twenty metres. This will increase the current, and allow people to draw water, bathe, or wash themselves and their cooking and eating utensils.

## **12.5. Chemical control**

Chemical control involves applying molluscicides to infested waters. If the prevalence of schistosomiasis is low in the local population, no treatment is necessary. Otherwise, the development sites of snails must be located and mapped for subsequent treatment.

### *Targets*

The molluscicide must be applied within a radius of 15 metres around the development sites after clearing away the aquatic vegetation.

To evaluate the effectiveness of treatment, place several live snails in a submerged cage and observe whether the molluscicide kills them.

### *Molluscicides*

Currently, niclosamide is the only effective chemical product, and the only molluscicide readily available on the market.

### *Application methods*

Niclosamide comes in two formulations: a 70% wettable powder, and a 25% emulsifiable concentrate. The product must remain in the treated water in effective concentrations for at least 8 hours. The following doses are recommended: 4-8 mg of niclosamide per litre of water to treat snails living in the water, and 0.2 g/m<sup>2</sup> for snails which are out of the water.

In running water, the quantity of molluscicide needed must be calculated according to the flow of the water (see annex 9). This type of treatment requires detailed technical knowledge and can be applied only by experienced personnel.

### *Frequency of treatment*

Treatment must be applied before the start of the schistosomiasis transmission period, which usually occurs near the beginning of the dry season. The relevant services of the Ministry of Health will be able to provide the information needed for planning treatments.

## 13. COMMENSAL RODENTS

Among the nearly 500 rodents that constitute the family of Muridae, three widespread species of commensal rodents can present a danger to public health, and cause considerable damage to foodstuffs. They are the Norway or brown rat, the roof rat, and the house mouse, all of which may live in or near human dwellings.

### 13.1. Biology

The largest of the three is the Norway rat (*Rattus norvegicus*), also called brown rat or sewer rat. It has a thick tail, small eyes, small ears only half of which project beyond the fur, and a rounded snout. It can weigh as much as 500 g, and can measure up to 45 cm from nose to tail tip (fig. 8). Its habitat can include holes dug in the ground, piles of garbage, warehouses, and sewers. Because it lives in sewers and feeds on garbage, it has a great potential for spreading disease. In the tropical zones of Africa, it is found only on the ocean coasts. The Norway rat is a poor climber.

The roof rat (*Rattus rattus*) is smaller, weighing about 250 g and measuring up to 40 cm from nose to tail tip. It has wide prominent ears, a very long and slender tail, and a pointed snout in comparison to the Norway rat. This excellent climber uses posts, telephone wires, trees, and drainpipes to reach stored food. It lives under roofs, along the joists and the top of partitions. The roof rat is present throughout Africa, except in desert and semi-desert regions.

The house mouse (*Mus musculus*) is the smallest of the three. It is about 18 cm long, weighs no more than 20 g, and can slip through openings only 1 to 2 cm wide, and nest in tiny shelters. The house mouse has a relatively smaller head and paws than a young rat. It is attracted to supplies of flour, cereals, and grain, but does not usually forage more than a few metres away from its home - in

contrast to rats, which may travel considerable distances in search of food. The house mouse was originally found only in the north of Africa, but it is continuously spreading and extending its range southward.

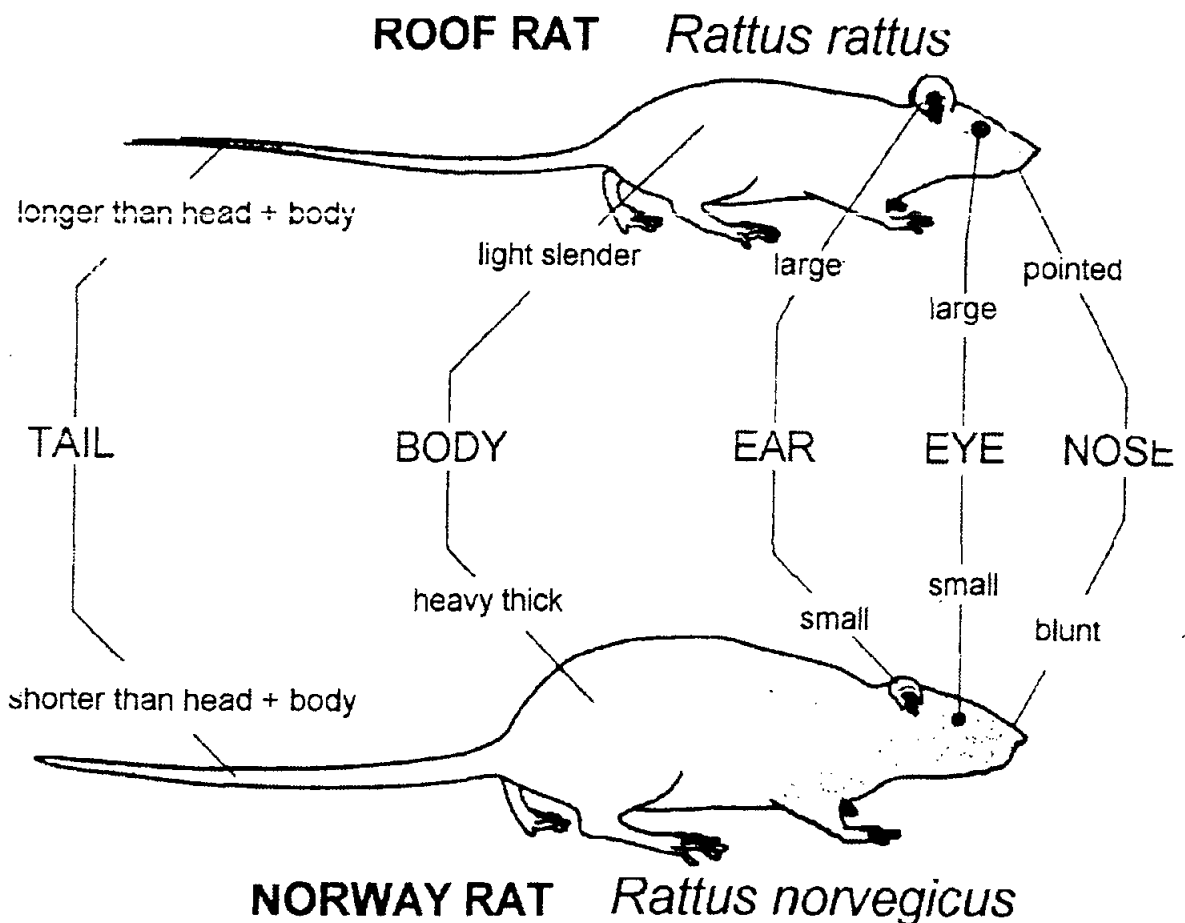

**Figure 8 - Morphological differences between the Norway and the roof rat**  
 According to Robert Z. Brown, Centre for Disease Control, US Public Health Service, Atlanta, GA., USA.

Other, less widespread domestic rodents can play a role in the local transmission of diseases. One example is the multimammate rat (*Mastomys natalensis*) found in Africa, south of Sahara. This is a small rat, not more than 25 cm from nose to tail tip. It eats plant and animal material, and is considered peridomestic.

When rats leave their nest, they follow a favourite path, keeping to the walls rather than crossing an open space. Note also that rats and mice reproduce all year round, giving birth to litters of 5 to 8 young which become sexually mature in two months.

### **13.2. Medical importance**

The risks to human health from commensal rodents are listed below, along with common examples of transmitted diseases:

#### Risks due to fleas

Rat fleas such as *Xenopsylla cheopis* can transmit two diseases, either to humans or to other rats. These are murine typhus (caused by *Rickettsia mooseri*), and the plague (caused by *Yersinia pestis*). If an epidemic occurs, fleas must be controlled by dusting insecticides into rat holes and along their favourite paths.

#### Risks due to dejection

If humans eat food contaminated by rat excrement, they may get food poisoning (salmonellosis), or they may contract very serious diseases such as leptospirosis and Lassa fever. In Africa, the multimammate rat (*Mastomys natalensis*) is the principal vector of Lassa fever.

#### Risk due to bites

A rat's bite can transmit micro-organisms which cause fever (sodoku and Haverhill fever) as well as rabies in humans.

Dead rats are also capable of transmitting diseases. People may contract leptospirosis when handling the carcasses of infected rats, or they may get trichinosis (helminthiasis) from eating the undercooked meat of pigs which have previously eaten carcasses of infected rats.

### **13.3. Economic importance**

Commensal rats and mice can cause considerable damage in places where food and other goods are stored. By contaminating food or destroying its containers, they diminish food stocks. Rodents also chew on other materials (lead, aluminium alloys, plastics, etc.), thereby damaging piping and the sheaths of electric cables. The stripping of wires is a particular hazard because it may cause short-circuits, which can lead to fires.

### **13.4. Hygiene measures**

Control measures should focus on preventing colonisation of dwellings by rats and mice, and eliminating any rodents already established.

### **13.4.1. Garbage management**

A domestic garbage management programme is necessary to prevent rodents from feeding and reproducing freely. Closed garbage bins must be made and used, and garbage must be removed regularly, taken to a dump site, and buried.

The areas around dwellings and storehouses must be cleared of garbage and general debris. The goods in storehouses must be tightly sealed, and the inventory should be kept to a minimum to reduce losses if goods are contaminated or destroyed. Leaving space between the walls and stored goods will reduce the number of sheltering and nesting places available to rodents.

### **13.4.2. Mechanical protection**

To prevent entry of rodents into dwellings:

- find all openings more than 6 mm in diameter (the smallest hole through which a young mouse could pass) and plug them or fit them with rodent-resistant grids;
- fill with mortar the spaces where pipes penetrate walls;
- reinforce the bottom of doors with metal plates (galvanised steel 1 mm thick and 30 cm high);
- fit ventilation holes with metallic grids (about 1 mm thick with a mesh of 6 mm max.);
- install rat baffles made of galvanised steel plates sticking out at least 25 cm over downpipes or other means of access from above;
- apply a strip of smooth paint about 10 cm wide on rough, vertical surfaces such as brick walls in order to stop rodents from climbing them.

### **13.5. Traps**

Commensal rodents can be eliminated physically, periodically outside dwellings, and continuously inside, by means of baited or unbaited traps. There are various types of traps and it is necessary to choose the best adapted to the local conditions. They could possibly be made on the spot using whatever materials are available. When setting traps either outdoors or indoors, it is advisable to:

- leave unset traps around for a few days to accustom the rodents to their presence;
- bait unset traps with normal food to accustom the rodents to taking the bait;



- always clean the traps after capturing;
- bury rat carcasses deeply, rather than incinerating them.

There are other methods of control for commensal rodents, such as chemical substances (thiram, cycloheximide, R-55), and electric and ultrasound barriers that have a repelling effect, but they are difficult to apply in refugee camps.

Often, a single method is not sufficient to reach an effective and durable control, and it is necessary to combine or alternate different methods, including the use of rodenticides.

### **13.6. Chemical control**

This involves the use of bait poisoned with rodenticides, or in rare cases, the use of toxic gas (fumigation).

#### **13.6.1. Use of rodenticides**

Rodenticides are pesticides used to kill rats or mice. They can be mixed with bait or with water, and are of two types:

- multiple dose toxic products (anticoagulants);
- single dose toxic products.

##### ***Multiple-dose toxic products (anticoagulants)***

These are called anticoagulants because they inhibit blood coagulation; the animal then dies by internal bleeding. These must be applied repeatedly.

The quantity of anticoagulant to be mixed with the bait varies according to the product and the target. The amount of bait placed in each location must be 25 g for mice, and 200 g or more for rats.

Table 5 shows some anticoagulant rodenticides, their methods of use and their characteristics.

**Table 5 - Multiple-dose anticoagulant rodenticides**

Rodenticide	Generation	Concentration in bait (%)	Characteristics
Warfarine	1 <sup>st</sup>	0.005-0.025 Norway or roof rat 0.025-0.05 house mouse	first anticoagulant used as rodenticide
Rozol	1 <sup>st</sup>	0.005 Norway or roof rat 0.01 house mouse	more toxic than Warfarine, can also be used as powder
Fumarine	1 <sup>st</sup>	0.025 Norway or roof rat 0.025-0.05 house mouse	similar to Warfarine
Difenacoum	2 <sup>nd</sup>	0.005 all rodents	efficient against rodents resistant to other anticoagulants
Bromadiolone	2 <sup>nd</sup>	0.005 all rodents	efficient against rodents resistant to other anticoagulants

Some anticoagulants are available in adhesive formulations which stick to the fur and paws of the rodents, and are ingested during preening. They must be spread in the holes and along the pathways of rodents.

Multiple-dose anticoagulants generally kill the house mouse in five weeks, the roof rat in four, and the Norway rat in three. Anticoagulants are popular formulations because they are effective, safe to use, and are the least toxic of the rodenticides. Resistance to multiple-dose anticoagulants has been reported, especially in the Norway rat and the house mouse, more rarely in the roof rat. If resistance occurs, rodents can then be controlled with single-dose poisons.

### ***Single-dose toxic products***

Where it is necessary to quickly reduce the commensal rodent population, single dose (and highly toxic) poisons such as thallium sulphate, arsenic oxide, or zinc phosphide are used. Once absorbed, they act in less than an hour. These products are mixed in with baits at a concentration of 1.5%. The baits must be divided into small quantities: 10 g for mice, and 50-100 g for rats, and placed wherever traces of rodents have been found.

Industrialised countries have banned the use of these products but they remain widely available in developing countries. It is obvious that the use of rodenticides in African rural zones represents a considerable danger to non-targeted fauna.

### **13.6.2. Fumigation**

Fumigation is used to kill domestic rodents and their ectoparasites living in inaccessible areas of dwellings (pipe galleries), in enclosed areas (ships), or in their holes. The method consists of smoking the rodents with toxic gasses such as hydro-cyanic acid or methyl bromide. The rooms of dwellings must be hermetically sealed (doors and windows closed, and cracks filled in) for fumigation to be effective.

Fumigation is an extremely dangerous procedure, both for the operators and for people and animals living in the immediate vicinity, and must be performed only by specialists. For these reasons, it is rarely justified in refugee situations.

## 14. ORGANISATION OF A CONTROL PROGRAMME

### 14.1. Methods

In order to organise a vector control programme, objectives, strategies and indicators must be clearly defined, and activities planned. Personnel and materials will depend on availability, and the animals targeted.

#### 14.1.1. Objectives

Animals targeted for control in refugee camps include arthropods, snails, and commensal rodents.

The aim is to reduce their numbers to tolerable levels, or levels which present no risk of causing epidemics.

#### 14.1.2. Strategies

A control programme must benefit people, while minimising the effect on non-target organisms and the environment. It must be based on rigorous scientific principles. Cost/benefit evaluations must take into account all socio-economic, health, and ecological aspects.

The risk of pesticide poisoning dictates that non-chemical methods of pest control must always be explored before chemical pesticides are used. They can be used only in cases of serious dangers to public health or in presence of a considerable nuisance. In the case of commensal rodents, economic aspects may also be considered.

Control strategies must vary according to the biology and ecology of the animal targeted. These strategies must consider the breeding sites and behaviour of the species.

A census must be taken of the target animals within and adjacent to refugee camps. The drawing of detailed distribution maps of development sites and camp dwellings is needed in estimating the personnel, equipment, and materials required, and in planning the logistics of the operation.

In the camps, the distribution of the vector borne diseases is not homogenous but strictly focused as it is related to the geomorphology of the soil. It will therefore be necessary to conduct a detailed stratification of the diseases in order to define the priorities.

Often, it will be necessary to extend the control activities in refugee camps to the outlying areas and neighbouring villages, over a distance of 3 kilometres.

### **14.1.3. Indicators**

Once the strategies have been defined, the general and specific objectives have to be associated with indicators in order to evaluate the effectiveness of the measures adopted. While it is possible, on the basis of epidemiological data, to define the percentage of vector reduction necessary to interrupt the transmission of a disease, it is not so easy to define the sufficient level of reduction required to relieve a nuisance as each individual's threshold of tolerance is different.

Indicators are sample counts of targeted animals per some unit of measurement. The unit of measurement may be a specified surface area, time period, individual person, etc., with the choice depending on the particular animal targeted, and the feasibility of counting them.

One example of an indicator is: the number of *Chrysomya* flies which land on a grill during a 30-second period. Table 6 lists other examples.

**Table 6 - Examples of indicators for estimating vector population density**

<b>Targeted animal</b>	<b>Indicators</b>
mosquitos	number of specimens collected per room (captured with pyrethrum) number of specimens collected per person per night (night-time capture on human bait)
blackflies	number of specimens collected per person per day (daily capture on human bait)
bugs	percentage of houses infested
sandflies	number of specimens collected per trap (oiled-papers or light traps)
ticks	number of specimens collected on sweeping cloth
flies	number of specimens collected per time unit on a standard grill
lice	percentage of persons found positive on inspection
fleas	number of specimens per trap (light and/or carbon dioxide)
scabies mites	percentage of specimens found positive on inspection

#### **14.1.4. Role of the Government of the host country**

Before undertaking a vector control programme, the relevant government Ministry of the host country must be consulted, especially if the use of pesticides is anticipated. Several African countries have national or regional programmes for controlling certain diseases transmitted by vectors (malaria, trypanosomiasis, onchocerciasis, etc.) which, in many cases, provide for specific vector control. The programmes exist either as separate entities focusing on a specific disease, or they are integrated into primary health care programmes. It is mainly the separate type of programme which is able to provide technical expertise and, in certain cases, respond quickly to crisis situations.

#### **14.1.5. Community participation**

Community participation should be encouraged because it allows individuals and families to assume responsibility for their own health and, hence, the health of the community. A community which is motivated to solve its own health problems will require less help from outside sources.

Community members must be made aware of the risks to their health, and must be taught the specific methods for minimising those risks. Proper sanitation is the single most effective measure in reducing the risk of disease: a clean community is more likely to be a healthy one.

Human behaviour in these situations plays an important role in the deterioration of the environment, creating favourable conditions for the development of vectors. Sanitary conditions can therefore be greatly improved by reducing the number and size of vector breeding sites, provided that the individuals, families and social groups are aware of the negative effect on their health of careless behaviour.

An organised community can also be involved in a control programme using pesticides. Indeed, provided that the community is convinced of the importance of the measures, it can help not only by providing information on location of larval breeding sites but also by taking part in the monitoring activities. In some cases, properly and fully-trained volunteers can be given responsibility for the application of pesticides, when necessary (see section 15.2.).

## **14.2. Installations**

The Agencies involved in using pesticides must have the following installations:

- warehouses for storing the pesticides and spraying equipment;
- a concrete area for cleaning of the equipment;
- soak pits for contaminated water;
- showers for the workers.

### **14.2.1. Storage and transport equipment**

Pesticides and pesticide application equipment must be stored in locked buildings. Make sure that pesticides are kept dry, away from flames, and not exposed to the sun. Store metal drums and cardboard boxes on wooden slats, and not directly on the ground, to prevent them from becoming rusty or soggy. If there is a risk of flooding, store boxes well above ground level.

Do not transport pesticides in vehicles used to carry food.

### **14.2.2. Cleaning of the equipment**

At the end of each day, carefully wash all spraying equipment to ensure that none of the pesticide remains in the tanks after use. This must be done on a concrete surface with raised edges to prevent the waste water from spreading (pl. 31). To clean, rinse out the spray tank completely. Then fill the tank with fresh water,

pump up the sprayer pressure, and run the water through the system. The filters of pre-set pressure sprayers should be stripped and cleaned periodically.

After washing, hang the drained sprayers upside-down, with lid open, from hooks on the warehouse wall. Before storing for a long period, strip each sprayer, and clean and dry all its parts.

#### **14.2.3. Waste water disposal**

To prevent waste water from contaminating drinking water, a watertight channel must run from the concreted area to a drainage pit, situated at least 100 metres from drinking water wells and dwellings.

After control operations are finished, do not dump containers of unused or left-over pesticide. Make sure that opened containers are resealed and properly labeled, and keep them stored along with any unopened containers in a locked building.

Do not reuse empty pesticide containers. Crush them if possible, then burn or bury them at a safe distance from all dwellings.

#### **14.2.4. Showering**

In order that workers who have been handling pesticides can wash regularly - or immediately in cases of contamination - a shower system must be made available, allowing at least 10 litres of water per person.

During spray operations, about 25 litres of clean water and soap must be on hand for use in case of accident.

### **14.3. Equipment**

According to their formulation, pesticides can be applied with different types of equipment. The choice and description will be limited to those most commonly used in Africa for vector control.



Liquid and wettable powder formulations are applied using hand-operated sprayers or motor-driven mist sprayers. Dry powders are applied using hand-operated dusters or motor-driven mist blowers which have been converted to dusters.

#### **14.3.1. Equipment for the application of solutions**

Sprayers are used for the residual treatment of surfaces, or for applying larvicides. They produce droplets having a diameter of 100-300 microns. Mistblowers are used principally for space spraying. They produce smaller droplets, having a diameter of 50-100 microns.

##### ***Hand compression sprayers***

Residual effect insecticides, larvicides, and molluscicides can be applied by hand compression sprayers.

The best-adapted type of sprayer, and that recommended by the WHO, consists of a cylindrical tank with a capacity of 8-10 litres, in which the insecticide solution is compressed by an air pump and projected evenly through a lance, on the end of which is a slit nozzle. A pressure-gauge on the tank indicates whether the correct pressure (from 25 to 55 psi) is being used during spraying. If there is no pressure-gauge, the number of strokes of the pump needed to produce a correct initial flow will have to be determined and monitored during the spraying (pl. 32). A harness attached to the tank allows it to be carried on a person's back (fig. 9).

Tank pressure drops during spraying, resulting in a decrease in flow, a wider angle of spray, and an increase in the size of the droplets. When this happens, the tank needs to be pumped again. The pumps should be calibrated periodically to ensure the correct flow-volume of liquid per minute.

The hand compression sprayer is the basic item of equipment in a vector control programme. Stainless steel models are better than plastic ones; if well maintained, they can last several years.

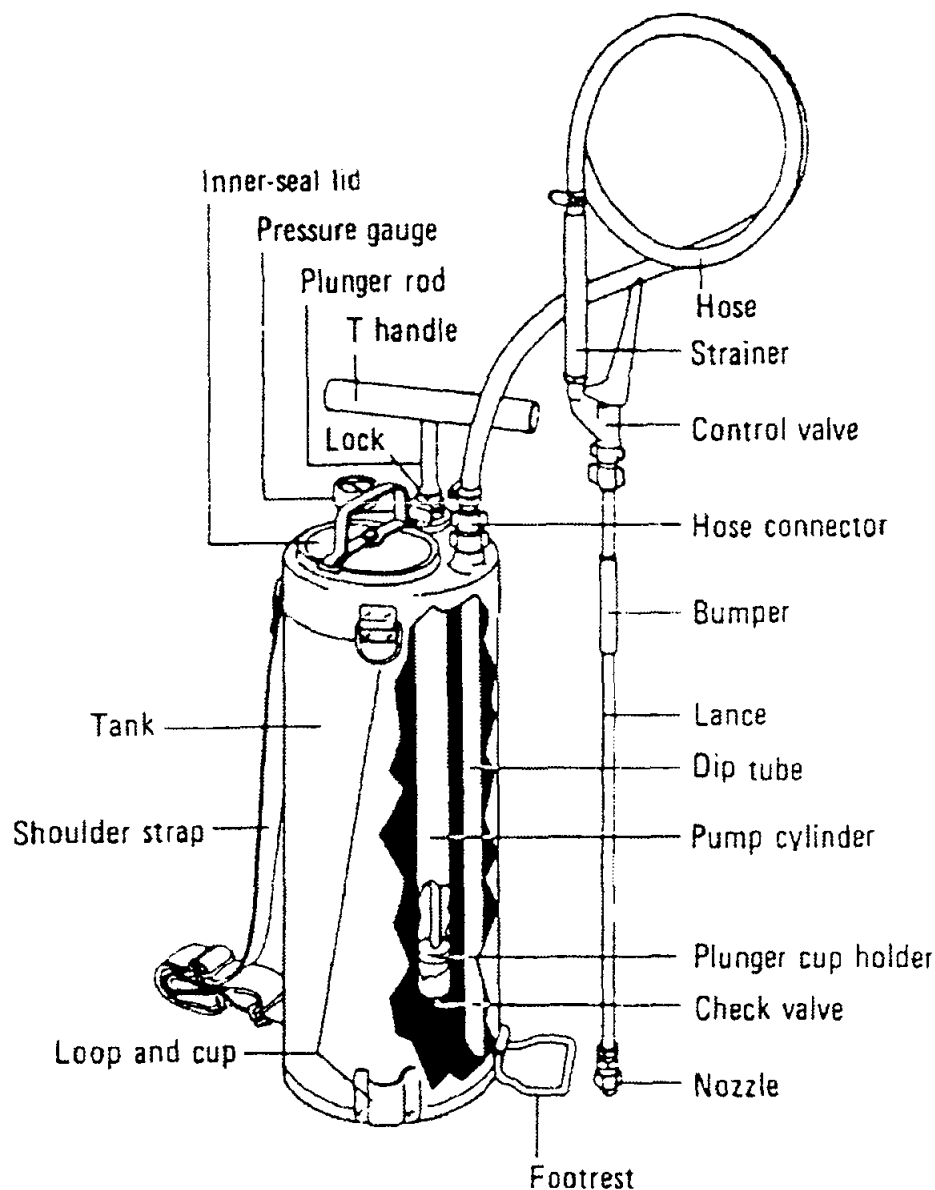

**Figure 9 - Hand compression sprayer**

Reproduced with the permission of the H.D. Hudson Manufacturing Company, Chicago, Illinois 60611 USA.

Application Standards

A combination of several factors influence the delivery of pesticide from the application equipment to the surface treated:

- the pesticide formulation used;
- the amount of pesticide in the tank;
- the air pressure in the tank;
- the size and shape of the nozzle opening;

- the distance between the nozzle and the surface to be treated;
- the speed of projection onto the surface to be treated.

The nozzle is the most important element for spraying. It delivers a specific quantity of liquid per minute at a given pressure and ensures a uniform, fan-shaped spray. Directions for obtaining the recommended spray fan width (65 to 70 cm) are:

- use a nozzle allowing a throughput of 760 ml per minute;
- adjust the spray angle to 60-65°;
- keep the nozzle 45 cm from the surface to be treated.

### ***Lever-operated sprayers***

These have a 12-15 litre tank usually made of plastic, and a piston or membrane pump that must be constantly worked by a lever. Two attached shoulder straps allow them to be carried on the back (pl. 31).

These sprayers are fairly common due to their moderate cost, but they do not allow uniform spreading of pesticide because the operator has to simultaneously pump the lever with one hand and direct the spray with the other. Therefore, they are used only for applying larvicides and molluscicides.

### ***Backpack motorised mistblowers***

These are activated by a small gasoline engine (35-70 cc), and two attached shoulder straps allow them to be carried on the back (fig. 10). The pesticide is sprayed in droplets and forced out of the device by air from a centrifugal fan. The flow and the dimension of the droplets varies according to the power of the motor, the viscosity of the product, and changes in the air/liquid ratio at the nozzle. These devices have a horizontal range of 9 to 12 metres; spray must always be directed downwind. Operators must wear hearing protectors because the engines are very noisy.

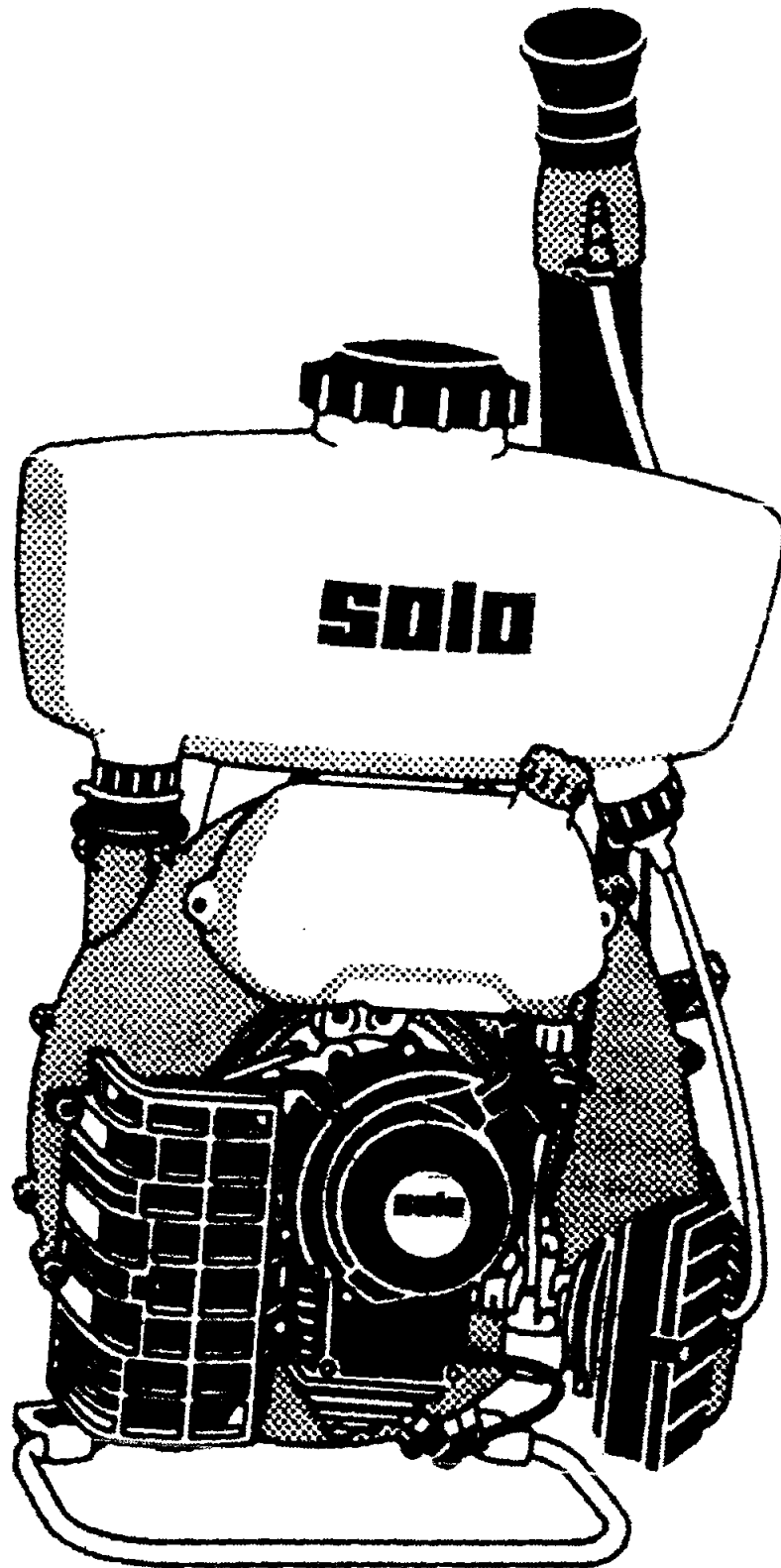

**Figure 10 - Backpack motorised mistblowers**

Reproduced with permission of Solo Kleinmotoren GmbH, Sindelfingen, 71050 Germany

Mistblowers producing large-dimension droplets (over 300 microns) can be used to treat particularly widespread larval development sites. Those producing finer droplets (between 100 and 300 microns) are used for adulticide treatments because the droplets remain suspended in the air for a long time, giving them more opportunity to kill flying insects, and penetrate the less accessible places.

### **14.3.2. Equipment for the application of solid materials**

#### ***Hand-carried dusters***

These consist of a piston pump attached to a tank for holding powder. Air is pumped into the tank, and powder is blown out through a hole which can be fitted with a hose for directing the spray (fig. 5).

Simplified dusters can be made from waste materials such as food cans pierced with holes, or loosely woven fabric bags which can be shaken or hit with a stick.

#### ***Backpack motorised dusters***

Some motorised mistblowers can be converted into dusters by interchanging the parts supplied by the manufacturer. They must be thoroughly cleaned and dried before being converted to a different use.

### **14.4. Personnel**

Organisation of personnel and associated equipment varies greatly from one programme to another. Below is described a typical structure of a residual treatment programme to control mosquitos inside dwellings that can be adapted to local needs and conditions.

The territory to be covered is divided into operational zones small enough to be treated by a single team during each application cycle. Zone size varies according to:

- the distribution and total area of surfaces to be treated;
- the yield per team;
- the accessibility;
- the means of transport available.

#### **14.4.1. Organisational flowchart**

The work of the various teams has to be co-ordinated and supervised by a section leader responsible for four or five teams of spray personnel.

Each team is composed of two to four spray persons, plus a team leader. Also, two assistants are necessary for each group of 4-5 teams, to help in preparing solutions and filling the pumps. Each team must be assigned a specific zone to treat each day, so that performance checks can identify which teams (if any) are not doing the job properly.

It is wise to have a backup team available, to treat dwellings that were missed by the spraying teams, and to give notice to members of the community the day before spraying is conducted. Extra personnel may also be required to wash protective clothing worn during applications.

One worker can use 8-10 handsprayers a day, each containing 8 litres of solution. Therefore, at an application rate of 40 ml of solution per m<sup>2</sup>, one worker can (theoretically) treat about 1,800 m<sup>2</sup> a day, or 36 dwellings of 50 m<sup>2</sup> each.

The following describes the responsibilities of various control programme personnel:

##### ***Section leader***

The section leader is responsible for ensuring good public relations, supervising and (if requested by a team leader) rotating staff, preparing work plans, co-ordinating transport, supplying insecticide and necessary equipment, checking work performance, and writing reports.

##### ***Team leader***

The team leader implements the work plans, supervises the work of spray personnel, completes the daily reports, and maintains relations with the local community.

### *Spray personnel*

These people are responsible for handling and applying pesticides in a safe and efficient manner. They should also note the number of dwellings treated daily, and the quantity of insecticide used.

#### **14.4.2. Training**

Before beginning residual effect spraying in the camps, spray personnel must be trained in the proper use of equipment, at the correct application speed. An application training area must be set up, and each worker must practice in covering an area of 19 m<sup>2</sup> per minute, including a 5 cm overlap between the sprayed strips, according to the following procedure:

- divide the surface of a building into 9 vertical strips, each 75 cm wide and 3 metres high;
- the sprayer must stand facing the first strip to be treated and keep a distance of 45 cm between the surface to be treated and the nozzle;
- start spraying while moving the lance evenly up and down;
- once the first strip has been treated, then, without stopping the spraying, take one step sideways and face the second strip;
- continue spraying with an up-down movement, covering the other 8 strips until the 19 m<sup>2</sup> have been covered.

The entire operation should take exactly one minute. Otherwise, the spraying speed will have to be adjusted. The operator must train until the correct speed is attained.

#### **14.5. Supervision and evaluation**

The UNHCR Medical Co-ordinator and Water/Sanitation Co-ordinator are responsible for co-ordinating and evaluating the overall activities. The impact of operations on the incidence of vector-transmitted disease and on nuisances caused by arthropods, as well as the cost/benefit ratio, must be evaluated periodically.

The agencies in charge of operations must conduct a continuous evaluation by quantitatively and qualitatively comparing the operational plans with the actual operations over a given period. This will allow the opportunity for any observed discrepancies or errors to be corrected in ongoing or subsequent operations.

The evaluation of vector control programmes should be based on periodic monitoring of vector populations and their susceptibility to insecticides. Resistance tests (see section 15.4.) require specialised equipment and technicians not readily available in refugee camps. Periodic visits by a vector control expert may be needed to conduct resistance tests and to resolve any technical problems that may have arisen during operations.

#### **14.5.1. Writing reports**

At the end of each day's activity, the team leaders must give to the section leader a report containing the following information:

- number of units (latrines, dwellings, larval development sites, etc.) treated;
- total quantity of insecticide used;
- total surface area (m<sup>2</sup>) treated.

Each week, the section leaders must compare the amount of work done against the amount that was planned, and record the quantity of pesticide used, the personnel employed, and the targets (see annex 3). An on-site evaluation of the spraying will also be conducted to verify adequate surface coverage and proper application rates.



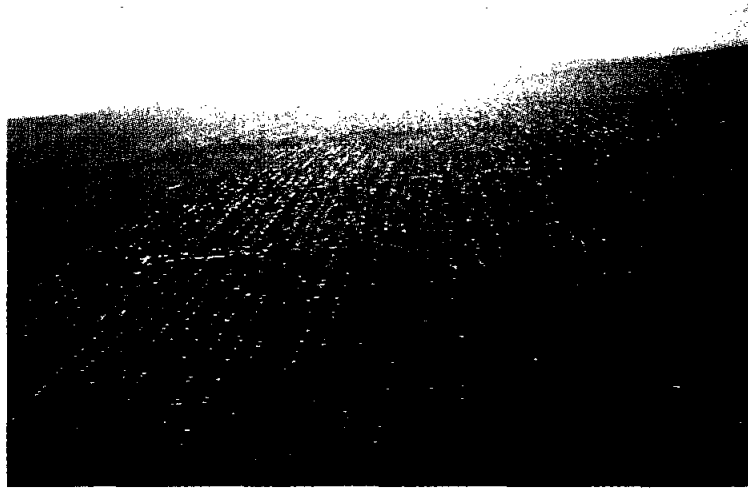

**Plate 1 - Aerial view of Benaco camp (Tanzania, Ngara) housing about 200,000 refugees (May 1995).**



**Plate 2 - View of Kanganiro camp (Zaire, Uvira) housing about 23,000 refugees (June 1995).**



**Plate 3 - Blindés at Ruvumu camp (Burundi, Ngozi).**



**Plate 4 - Blindés at Burigi camp (Tanzania).**



Plate 5 - Dips in the ground full of water, *Anopheles gambiae* larval development sites.



Plate 6 - Collection of mosquitos on a capture sheet following pyrethrum spraying in a dwelling.



**Plate 7 - Residual insecticide spraying inside dwellings.**



**Plate 8 - Insecticide-impregnated mosquito net used in combating malaria.**



**Plate 9 -** Insecticide-impregnated curtain used in combating malaria, in the savannah zone.

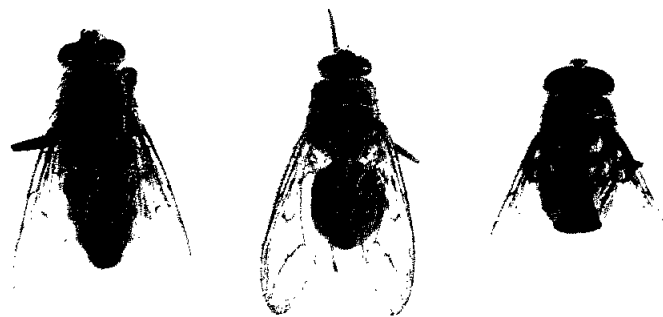

**Plate 10 -** Flies of the genera *Sarcophaga*, *Glossina*, and *Chrysomyia* (left to right).



Plate 11 - Larvae (maggots) of *Chrysomya* flies developing in a latrine.



Plate 12 - Fly traps installed on the defecation hole of a latrine.



Plate 13 - *Chrysomya* flies on a can containing a sweetened alcoholic drink.



Plate 14 - *Chrysomya* flies on vegetation near garbage dumps.

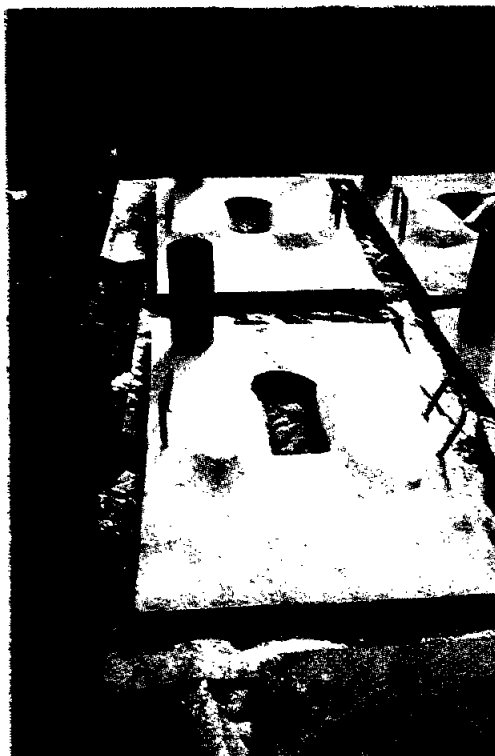

**Plate 15 - Communal latrine in Mugano camp (Burundi, Muyinga).**



**Plate 16 - Construction of a cement dome slab for a latrine at Musuhura camp (Tanzania, Ngara).**





**Plate 17- Construction of a cement slab for an improved ventilated pit latrine in Benaco camp (Tanzania, Ngara).**



**Plate 18 - Incinerator for hospital waste at Mtabila camp (Tanzania, Kigoma).**



Plate 19 - Bercol<sup>®</sup> type fly traps.

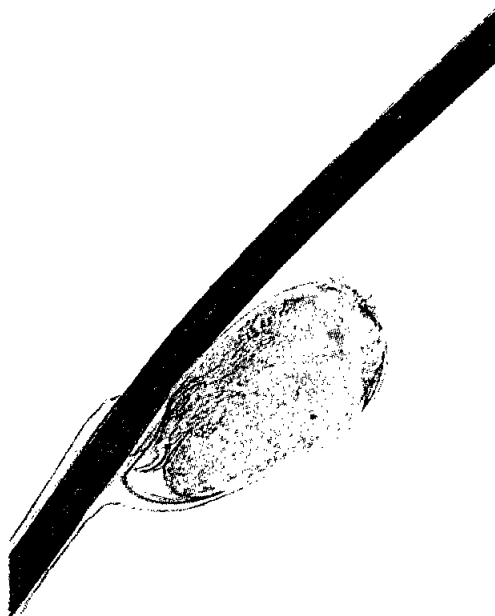

Plate 20 - Egg of the head louse (nit), *Pediculus capitis* attached to a hair.



Plate 21 - Body louse (*Pediculus humanus*) .



Plate 22 - Pubic louse (*Phthirus pubis*) .



Plate 23 - Human flea (*Pulex irritans*).



Plate 24 - Cutaneous lesions caused by flea bites.

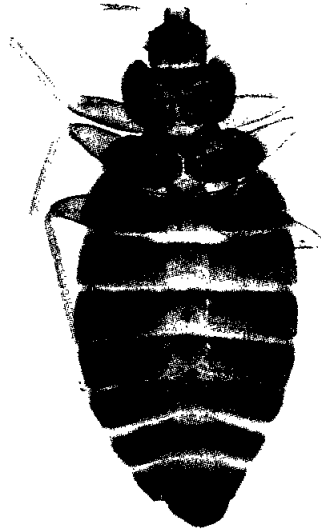

Plate 25 - Bed bugs (*Cimex lectularius*).

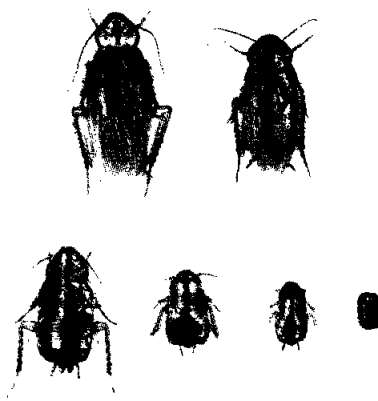

Plate 26 - Stages in the development from the egg (ootheca) to adult, in the cockroach *Periplaneta americana*.



**Plate 27 -** A screen impregnated with insecticide to attract and control tsetse-flies (*Glossina*).



**Plate 28 -** Swamps near a refugee camp in the Uvira region (Zaire), a focus of intestinal schistosomiasis.



**Plate 29 - Drinking water supply in a refugee camp in the Ngara region (Tanzania).**



**Plate 30 - Wash facilities in a refugee camp in the Ngozi region (Burundi).**



**Plate 31 - Cemented area for washing equipment used for insecticide spraying (lever-operated sprayers ).**



**Plate 32 - Preparation of a hand compression sprayer for insecticide spraying.**



## 15. PESTICIDES

### 15.1. Classification and characteristics

Before the discovery of DDT and other residual insecticides, vectors were controlled mainly by repeated applications of insecticides. The importance of residual insecticides appeared after the Second World War, when DDT was massively tested and proved to be an excellent contact pesticide, with a long residual effect against vectors. The intoxication and death of insects are due to the absorption of the product by contact and sometimes also by inhalation. Persistence is related to contact. The choice of insecticide must take account both of its toxicity and biological action and of safety and ease of use.

Insecticides are classified in the following categories based on chemical structure:

- **Organochlorines** (e.g. DDT, Dieldrin). Few of the organochlorines are now in use because they have a long persistence in the environment, tend to accumulate in the fatty tissues of humans and animals, are extremely toxic to fish, and a number of insects have developed resistance to them. They have a residual effect of six months or more, and are moderately toxic to mammals. Oral toxicity in rats is 113 (DDT) or 40 (Dieldrin) mg/kg body weight.
- **Organophosphates** (e.g. malathion, fenitrothion, pirimiphos-methyl, temephos). These have a residual effect of two or three months. Malathion is highly toxic to fish and bees, whereas temephos is not. They have a low to moderate mammalian toxicity. Oral toxicity in rats is 1,000 (malathion and temephos) or 130 (fenitrothion) mg/kg body weight.
- **Carbamates** (e.g. propoxur, bendiocarb). These have a residual effect of two to three months. Bendiocarb is highly toxic to fish. They are moderately toxic to mammals. Oral toxicity in rats is 40 (bendiocarb) or 80 (propoxur) mg/kg body weight.
- **Pyrethrins** (natural extracts of *Chrysanthemum cinerariaefolium* flowers). They have excellent insect knockdown properties, but are quickly broken down when exposed to light, moisture, or air, and therefore do not have any residual effect. They are highly toxic to fish, and moderately toxic to mam-

mals. Oral toxicity of pyrethrins in rats is 200 mg/kg body weight. However, since they break down so quickly and leave no dangerous residues, their hazard to humans after application is nil.

- **Synthetic pyrethroids** (e.g. deltamethrin, permethrin, lambda-cyhalothrin). These are not quickly broken down by light and have a residual effect of 2 to 3 months. They are highly toxic to fish, but have a very low mammalian toxicity. Oral toxicity in rats is 4,000 (permethrin) or 5,000 (deltamethrin) mg/kg body weight.

## 15.2. Toxicity

The WHO divides pesticides into 5 classes, according to the risks they present to health after a single exposure or multiple exposures over a comparatively short period. Account is taken of the toxicity of the active ingredient ( $LD_{50}$  absorbed orally, or otherwise) as well as its concentration in the formulation.

- **Class Ia:** includes extremely dangerous substances that can be handled only by operators bearing a special licence;
- **Class Ib:** includes very dangerous substances that can be handled by fully trained personnel, under strict supervision;
- **Class II:** includes moderately dangerous substances that can be handled under supervision by trained personnel who can be relied upon to respect the prescribed safety measures;
- **Class III:** includes substances that are not very dangerous and that can be handled by personnel who will observe routine safety measures;
- **Class 0:** includes substances that are not dangerous in normal use and that can be handled by any person respecting hygiene measures (in particular, those appearing in the package leaflet).

The pesticides mentioned in this manual have already proved effective and safe to humans when used in refugee camps in East Africa. All are class III pesticides except for fenitrothion, which belongs to class II.

## 15.3. Formulations

Many pesticides can produce a biological effect at extremely low doses (a few grams or milligrams per  $m^2$ ). Such small quantities of material cannot be

uniformly distributed over a large area unless they are first diluted or mixed with a much greater quantity of another material. These operations are performed industrially, and the resulting commercial products are called “formulations”. They consist of a given quantity of pesticide (termed the “active ingredient”, or “a.i.”), together with other ingredients which make the product easier to apply. The percentage of a.i. and the degree of purity of each formulation has to be known in order to make up the correct dose for use.

Formulations are classified in the following categories based on their physical and chemical properties:

- **Emulsifiable concentrates.** These are solutions containing an active ingredient, a petroleum-based solvent, and an emulsifier which allows the formulation to be mixed with water. This formulation is fairly easy to use, and is one of the most common.
- **Liquid concentrates.** These usually contain small amounts of active ingredient and a petroleum solvent. They must be diluted in fuel oil or kerosene before use. They are most often used to produce aerosol mists, generated by thermal foggers.
- **Dry powders.** These are made up by mixing the finely-crushed a.i. with insoluble, inert powders in water. They require no mixing, and can be used in controlling human ectoparasites (lice, fleas, crab-lice), and cockroaches or other crawling insects.
- **Wettable powders.** In these formulations, the a.i., which is not soluble in water, is mixed with an inert powder and a wetting agent that helps it quickly disperse in water. The mixture must be prepared by adding the wettable powder to water just before use. The resulting preparation is a suspension, which must be continually agitated to prevent it from settling out. These powders are used principally for the residual treatment of surfaces.
- **Granules.** These are inert particles (clay, corncob, kaolin) impregnated with insecticide. Granules are ready for use, and are applied directly to water where mosquito larvae develop. The granules are scattered by hand or by motorised mistblowers converted to granule applicators.

#### 15.4. Resistance to insecticides

When insecticides are used against an arthropod population, they exert selective pressure on all the individuals. In other words, the arthropods are being pressu-

red to survive, and the ones that do are said to be “resistant”. Insecticides with long persistence exert greater selective pressure, thereby increasing the likelihood that resistance will develop.

The factors that determine the survival of specimens to the action of insecticides can be genetic, biological, behavioural, or operational. Certain genes are responsible for different degrees of susceptibility to insecticides. Resistance can spread very quickly throughout a population of insects which produce many offspring per generation, and several generations per year. The spread of resistance across the terrain is determined by the mobility of individuals: flying insects may spread resistance over great distances.

To reduce the likelihood of resistance development, insecticides with long persistence should be replaced by, or alternated with, the use of those having shorter persistence. It is also advisable to alternately use pesticides which have different modes of action.

Monitoring the susceptibility of arthropods to insecticides is part of the continuous evaluation that must be done in vector control programmes. The techniques used differ according to the insects and the targeted stage of development, but they always consist in exposing specimens to increasing doses of insecticide and determining the lethal dose for one-half ( $LD_{50}$ ) or for 95% ( $LD_{95}$ ) of them. This method can be simplified by using only a pre-established concentration of insecticide, called the “diagnostic dosage”. The WHO publishes documents describing these techniques in detail for each group of arthropods and also provides the equipment necessary for conducting the tests, as well as instructions for the correct interpretation of the results. These tests can be reliably conducted only by a trained technician.

### **15.5. Legislation**

The use of pesticides is more or less regulated, depending on the country. Before a pesticide is bought or used in a particular country, it must be authorised for purchase or use there. Permission must first be obtained from the department(s) responsible for issuing permits, taking care to specify that the pesticides are to be used in public health, and not in agriculture. The Ministry of the host country responsible for Health can provide help in acquiring the permit as well as the list of pesticides approved in that country.

Internationally, the three main reference bodies for the regulation of pesticides are:

- the World Health Organisation (WHO) whose classification of chemical products into 5 groups allows for a choice between the various products and for determining the safety standards to apply (see section 15.2.);
- the United Nations Food and Agricultural Organisation (FAO) whose “International Code of Conduct on the Distribution and Use of Pesticides” (1990 amended version) can be very useful for countries that do not yet have any pesticide regulations;
- the United Nations Environmental Programme (UNEP) whose publication entitled “London Guidelines for the Exchange of Information on Chemicals in International Trade” (1989 amended version) contains directions for finding information on hazardous products, public health, and the environment.

It is recommended that WHO standards be followed in the purchase and transportation of pesticides and pesticide equipment (see the “Selected Bibliography” section). Pesticide packaging and labelling is very important. The label must provide full details of the contents, use, safety regulations, and action to be taken in case of poisoning.

Receipt of damaged or expired pesticides must be immediately reported to the purchasing service, who will then arrange for a replacement shipment, and ensure that the problem does not happen again.

## 16. SAFE USE OF INSECTICIDES

Insecticides are harmful not only to insects, but also to humans. They must therefore be handled with care. The following recommendations must be respected before beginning a spraying campaign.

### 16.1. Protection and hygiene of the personnel

The following precautions must be followed by people using chemical insecticides:

- spray personnel must be properly instructed and fully trained in pesticide use, and warned of the dangers of pesticide poisoning;
- their faces must be protected and they must wear rubber gloves;
- they must receive detergent and soap each week, for washing their work clothes and themselves;
- their work clothes must cover the entire body, must be removed immediately after work, and must be washed frequently. Ordinary cotton clothes are preferable;
- workers must not spray for more than 4 or 5 hours a day;
- spraying must be supervised;
- insecticides must be handled using ladles or spoons, and mixed using sticks in basins having handles, in order to avoid any hand contact with the products;
- workers must take a shower with soap after each day's work, or each time they accidentally have any contact with the insecticide;
- equipment must be kept in good condition;
- spray personnel must use the minimum pressure necessary to deliver a good spray;
- a stock of injectable atropine must be kept on hand in case of organophosphate poisoning.

Emulsifiable concentrates are more hazardous to handle than wettable powders because absorption through the skin is faster and more massive.

If pesticides are applied properly, there is very little risk to the occupants of dwell-

lings. Food must be removed or carefully covered before a dwelling is treated.

The following protective clothing must be made available to each sprayer:

- 2 light, comfortable long-sleeved cotton overalls;
- 1 pair of rubber boots;
- 2 broad-brimmed hats;
- 1 pair of plastic safety glasses;
- 2 felt masks and 1 respiratory half-mask with filter cartridge (to be used during space spraying);
- 2 pairs of rubber gloves.

The insecticide mixers must have a plastic apron, rubber gloves, and rubber boots.

## **16.2. Pesticide poisoning and first aid**

All those in charge of supervising workers handling pesticides must be able to quickly diagnose a case of poisoning, and take the proper action.

### **16.2.1. Organophosphates**

Poisoning or overexposure produces symptoms quickly - typically 1/2 hour to 1 hour later. They can appear somewhat later (2 to 3 hours) if the product entered the body through the skin.

The first symptoms of poisoning are nausea, headache, fatigue, and weakness, accompanied by mental and muscular disorders. Headache, muscle weakness, and fatigue increase progressively, followed by vomiting, abdominal cramps with diarrhoea, heavy sweating, and salivation. In serious cases, paralysis and breathing problems can be observed, followed by convulsions and a loss of consciousness, leading to coma, respiratory arrest, and death.

### **16.2.2. Synthetic pyrethroids**

These insecticides have very weak toxicity in mammals, and only oral doses in excess of 15 g are poisonous to humans. However, they can provoke contact dermatitis.

No case of pyrethroid poisoning has been reported in humans.

### **16.3. Emergency treatment**

On-the-spot emergency treatment may be necessary to neutralise the life-threatening effect of pesticide poisoning. Everything must be done to maintain normal breathing, while placing the patient in a well-aired place, in a safe position.

Insecticide contact with the eyes is always an emergency situation. The eyes must be immediately flushed with massive quantities of fresh water for about 10 minutes, keeping the eyelids wide open.

The contaminated person must be taken to a medical centre for further treatment. In cases of serious organophosphates poisoning, 2 to 4 mg of atropine-sulphate must be injected into a muscle or vein as soon as possible. The effect of atropine given intravenously is usually apparent in 3-4 minutes.

### **16.4. Laboratory tests**

Organophosphates are cholinesterase inhibitors. Cholinesterase is an enzyme in the body which allows the normal transmission of nerve impulses. If a person has been overexposed to organophosphates, a blood test will reveal lower-than-normal levels of cholinesterase in their blood. However, "normal" levels vary among individuals, so each person's cholinesterase level must be measured before any exposure takes place.

Colorimetric tests are available for field situation use and can be obtained through the WHO office.



## GLOSSARY

The definitions have been adapted to the context of this manual. The words in italics refer to terms defined in the glossary.

**Acaricide** - a pesticide used to kill mites and ticks.

**Acarids** - an *arachnid* belonging to the order Acarina, which includes ticks and scabies mites. Mites have three pairs of legs in the larval stage, and four in the nymph and adult stages. The abdomen is not segmented.

**Active ingredient (a.i.)** - the portion of a *pesticide formulation* which is the actual toxicant.

**Acute toxicity** - the potential for an ingredient to cause ill health or death within a few hours to a few days after a single dose or exposure.

**Adulticide** - (noun) a *pesticide* used to kill adult *arthropods*; (verb) to kill adult *arthropods*.

**Aerosol** - very tiny (from 0.1 to 50 microns) liquid or solid particles suspended in the air.

**Approval** - registration by a government authority of the production or import, sale, and use of a *pesticide* (in most cases, approval is granted after evaluation of complete scientific data concerning the effectiveness and the safety of the product).

**Arachnid** - an *arthropod* belonging to the class Arachnida, which includes spiders, scorpions, mites & ticks, and others. Arachnids have two distinct body regions (cephalothorax, and abdomen), four pairs of legs in the adult, no antennae, and no wings.

**Arthropod** - a small invertebrate (having no backbone) animal with an external skeleton and jointed appendages. Arthropods include the *insects*, *arachnids*, crustaceans (crabs, shrimp, etc.), millipedes, centipedes, and others.

**Biological control** - a group of control methods using *biological insecticides* or living organisms.

**Biological cycle** - development stages through which an organism passes in one generation.

**Biological insecticide** - an *insecticide* in which the *active ingredient* is a micro-organism (e.g. the bacterium *Bacillus thuringiensis*).

**Blindé** - in the Great Lakes region of Africa, a name given to the shelters built by refugees, consisting of a wooden semi-cylindrical structure covered with a plastic sheet. The front and back walls are usually made of plaited straw.

**Blood-sucker** - organisms which feed on blood.

**Carbamates** - a synthetic *pesticide* made from carbamic acid (e.g. bendiocarb, carbaryl, propoxur).

**Chitinous** - referring to the tough, rigid skin of *arthropods*, composed of layers of a compound called chitin.

**Cholinesterase** - a body enzyme (chemical catalyst) whose action in conducting nerve impulses is inhibited when *organophosphate* or *carbamate pesticides* penetrate the organism.

**Concentration** - the weight of *active ingredient* in a given weight or volume of a *formulation*.

**Diptera** - an order of *insects* comprising the true flies. Diptera have only one pair of functional wings; the second pair has been reduced to small knobbed structures called halteres.

**Ectoparasite** - a parasite which lives on the outside surface of the *host*.

**Emulsifiable concentrate** - a liquid *pesticide* consisting of an *active ingredient*, a *solvent*, and an *emulsifying agent* that mixes with water to form an *emulsion*.

**Emulsifying agent** - a material which helps to suspend one liquid in another, such as oil in water.

**Emulsion** - a combination of two or more unmixable liquids, such as oil and water, where one is suspended or dispersed in the other in the form of very minute droplets, and remains in that state for a period of time through the use (addition) of an emulsifier.

**Endemic** - a disease or organism which is always present in a certain geographic region, but never increasing.

**Erythema** - congestive redness of the skin which disappears under finger pressure.

**Erythrosis** - (flushing) reddening of the skin or mucosa.

**Etiologic agent** - an organism that causes disease.

**Exophilic** - this describes *insects* that do not normally enter buildings. If buildings are entered, the insects do not remain there.

**Formulation** - a mixture of one or more *active ingredients* together with other materials (e.g. *vehicles, solvents*) to make it safe and easy to store, transport, dilute, and/or apply.

**Filaria** - a nematode worm transmitted to humans and animals by insect bites.

**Habitat** - the area or type of environment in which an organism normally lives.

**Host** - a living organism that maintains or harbours an infectious agent or *parasite*.

**Incidence** - the number of new cases of an illness or disease arising in a given population over a stated period. It is usually expressed as a rate (e.g. the number of cases per 1,000 individuals at risk). Compare *prevalence*.

**Infestation** - the presence of animal *parasites* either on the skin or inside the body of the host; also, the invasion of a place by *arthropods* in numbers large enough to be harmful or obnoxious.

**Insecticide** - A *pesticide*, in various *formulations*, used to kill insects or other harmful *arthropods*.

**Insect** - an *arthropod* belonging to the class Insecta. Insects have three distinct body regions (head, *thorax*, and abdomen), three pairs of legs, one pair of antennae, and usually one or two pairs of wings in the adult.

**Lance** - an element linked by a hose to the tank of a spraying machine for directing the spray of the *solution*.

**Larva** - the intermediary stage between the egg and the *pupa*, in the development of the *arthropod*.

**Larvicide** - (noun) a *pesticide* used to kill *arthropod larvae*; (verb) to kill *arthropod larvae*.

**LD<sub>50</sub> (Lethal dose to 50%)** - the smallest quantity of a substance (expressed in milligrams of *pesticide* per kilogram of body weight of an animal) sufficient to kill 50% of such animals. LD<sub>50</sub> is a statistic used to indicate degree of toxicity.

**Metamorphosis** - the change in form during an *insect's* development.

**Molluscicide** - a *pesticide* used to kill slugs and snails.

**Myiasigenic** - causing a *myiasis*.

**Myiasis** - the *infestation* of living organs or tissues by fly *larvae*.

**Nozzle** - a piece fitted to the end of a *lance* for adjusting the spray pattern and droplet size of a sprayed *solution*.

**Oedema** - an accumulation of fluid in the skin that appears as a painless swelling without flushing and holds the imprint of the finger for some time.

**Organochlorine** - a man-made organic *pesticide* containing chlorine (e.g. DDT, Dieldrin).

**Organophosphate** - a man-made organic *pesticide* containing phosphorus (e.g. fenitrothion, malathion, pirimiphos-methyl, temephos).

- Parasite** - an organism which, for all or part of its life, lives in or on the body of another organism (the *host*), and obtains nourishment from it.
- Pathogen** - any disease-producing organism.
- Pathogenic** - disease-causing.
- Peridomestic** - living in or near human habitations.
- Persistence** - the time during which a *pesticide* retains its toxic properties after application.
- Pesticide** - any substance used to kill or control organisms considered to be pests.
- Plasmodia** - the organisms which cause malaria (Plasmodium falciparum, P.vivax, P.ovale, and P.malariae).
- Prevalence** - the number of current cases of an illness or disease in a given population, either at a particular time, or over a stated period. It is usually expressed as a rate (e.g. the number of cases per 1,000 individuals at risk). Compare *incidence*.
- Protozoa** - single-celled organisms, some of which cause disease (e.g. malaria, trypanosomiasis, leishmaniasis).
- Pupa** - the intermediary stage between the *larva* and the adult, in the development of an *insect*.
- Pyrethroid** - a man-made *insecticide formulation* whose *active ingredient* is derived from the dried flower heads of Chrysanthemum (pyrethrum) plants.
- Resistance (to insecticides)** - the ability of an organism to resist or suppress the effects of a *pesticide*. Resistance may appear in a population of *insects* after a period of repeated applications of the same *insecticide*.
- Rickettsioses** - a group of diseases caused by organisms of the genus Rickettsia or Rochalimaea.
- Rodenticide** - a *pesticide* used to kill rats or mice.
- Rodent**- a mammal belonging to the order Rodentia, which includes rats, mice, squirrels, muskrats, beavers, and others. Rodents lack canine teeth; their large incisors are adapted for gnawing or nibbling.
- Solution** - a homogeneous mixture of a solid, liquid, or gas, with a liquid, usually in greater quantity.
- Solvent** - a liquid which will dissolve one or more substances to form a *solution* (e.g. water, kerosene).
- Species** - a group of organisms whose individuals are similar in structure and physiology, and are capable of producing fertile offspring. A species is the smallest unit of classification currently used.

- Spirochete** - any one of a group of spiral-shaped bacteria, some of which (Borrelia) cause disease.
- Sporozoite** - the form and developmental stage of *plasmodia* that occurs inside an Anopheles mosquito, and is injected into humans when the mosquito bites.
- Suspension** - a liquid or gas in which very fine solid particles are dispersed but not dissolved. Constant agitation is necessary to prevent the particles from precipitating out of suspension.
- Synanthropic** - a term used to describe *insects* that live in the immediate environment of humans and on whom some depend.
- Systematics** - the study of the classification of living things.
- Tank** - the container of a pump in which the *pesticide solution* is pressurised by manual pumping.
- Thorax** - the *insect* body region (between the head and the abdomen) to which the legs and wings are attached.
- Toxin** - any poison of biological origin, and any substance that produces poisoning in the organism.
- Trade name** - a brand name belonging to the manufacturer or formulator of a product.
- Transmission** - the passing of a disease from one individual to another. A *vector* may be necessary.
- Vector** - any animal capable of transmitting disease from one host to another by its bite or bodily functions.
- Vehicle** - inert matter (e.g. talc, clay) used in the *formulation* of *pesticide* powders, and dispersible in water.
- Wettable powder** - a *formulation* of *pesticide* to which is added a *wetting agent* so that the powder can hang in *suspension* in water.
- Wetting agent** - a chemical product added to powdered *pesticides* to improve their dispersion in water and to enable them to spread and wet the surfaces to be treated more easily.

## BIBLIOGRAPHIC SELECTION

- AMERICAN MOSQUITO CONTROL ASSOCIATION 1990 - Organisation for mosquito control. AMCA Bull. 4, 71 pp.
- AZAD A.F. 1986 - Mites of public health importance and their control. Training and Information Guide XIII. WHO/VBC/86.931. WHO, Geneva, 52 pp.
- BRES P. 1986 - Public Health Action in Emergencies caused by Epidemics. WHO, Geneva, 287 pp.
- BROOKS J.E., ROWE F.P. 1987 - Commensal rodent control. Training and Information Guide. WHO/VBC/87.949. WHO, Geneva, 107 pp.
- COCHRAN D.G., GRAYSON J.M., GURNEY A.B. 1975 - Cockroaches, biology and control. WHO/VBC/75-576. WHO, Geneva, 48 pp.
- CURTIS C.F. editor 1990 - Appropriate Technology in Vector Control. CRC Press Boca Raton (Florida), 233 pp.
- DANIS M., MOUCHET J., EDITORS. 1991 - Paludisme. Collection Universités francophones, ELLIPSES, Paris, 240 pp.
- DAVIES J.B., CROSSKEY R.W. 1991 - *Simulium*, vectors of onchocerciasis. Training and Information Guide. WHO/VBC/91.992. WHO, Geneva, 115 pp.
- FAO. 1990 - International Code of Conduct on the Distribution and Use of Pesticides (amended version), FAO, Rome, 39 pp.
- FONTAINE R.E. 1978 - House spraying with residual insecticides with special reference to malaria control. WHO/VBC/78.704. WHO, Geneva, 28 pp.
- FRANCEYS R., PICKFORD J., REED R. 1995 - Guide de l'assainissement individuel. WHO, Geneva, 258 pp.
- GRATZ N.G., BROWN W.A. 1983 - Fleas, biology and control. Training and Information Guide XII. WHO/VBC/83.874. WHO, Geneva, 46 pp.
- INTERNATIONAL RICE RESEARCH INSTITUTE 1988 - Vector-borne Disease Control in Humans Through Rice Agroecosystem Management. International Rice Research Institute, Philippines, 237 pp.
- KEIDING J. 1986 - La mouche domestique, biologie et lutte antivectorielle. Guide de formation et d'information VII. WHO/VBC/86.937. WHO, Geneva, 65 pp.
- LAIRD M., MILES J.W., editors 1983 - Integrated mosquito control methodologies. Academic Press, London, 369 pp.
- LANOIX J.N., ROY M.L. 1976 - Manuel du technicien sanitaire. WHO, Geneva, 193 pp.

- LAVEISSIERE C. 1988 - Les glossines vectrices de la trypanosomiase humaine africaine, biologie et contrôle. Guide de formation et d'information XV. WHO/VBC/88.958. WHO, Geneva, 91 pp.
- MOUNT G.A. 1979 - Ultra-Low-Volume application of insecticides, a guide for vector control programmes. WHO/VBC/79.734. WHO, Geneva, 15 pp.
- NÀJERA J.A. 1996 - Malaria Control among refugees and displaced populations. CTD/MAL/96.6. WHO, Geneva, 62 pp.
- PAHO 1982 - Emergency vector control after natural disaster. Scientific publication No 419. PAHO, Washington, 98 pp.
- PHILLIPS M., MILLS A., DYE C. 1993 - Guidelines for cost-effectiveness analysis of vector control. PEEM Guidelines series 3. WHO/CWS/93.4. WHO, Geneva, 192 pp.
- PLESTINA R. 1986 - Intoxication par les insecticides: prévention, diagnostic et traitement. WHO/VBC/84.889, WHO, Geneva, 72 pp.
- RODHAIN F., PEREZ C. 1985 - Précis d'entomologie médicale et vétérinaire. Maloine, Paris, 458 pp.
- ROZENDAAL J.A. 1989 - Impregnated mosquito nets and curtains for self-protection and vector control. Tropical Diseases Bulletin, 86, 7, 41 pp.
- SMITH K.G.V. editor 1973 - Insects and other Arthropods of Medical Importance. British Museum, London, 561 pp + 12 pl.
- THOMSON M.C. 1995 - Disease prevention through vector control, guidelines for relief organisations. OXFAM Pratical Health Guide 10, 127 pp.
- UNEP. 1989 - London Guidelines for the Exchange of Information on Chemicals in International Trade (amended version), UNEP, 22 pp.
- WEIDHAAS D.E., GRATZ A.G. 1982 - Lice. WHO/VBC/82.858. WHO, Geneva, 10 pp.
- WEISER J. 1991 - Biological Control of Vectors. Wiley and Sons, 189 pp.
- WFP. 1992 - Food Storage Manual. WFP, Rome, 181 pp.
- WHO. 1970 - Instructions for the bio-assay of insecticidal deposits on wall surfaces. 17th Report of the WHO Expert Committee on Insecticides. Technical Report Series No 443. WHO, Geneva, 5 pp.
- WHO. 1971 - Phlebotomine Sandflies. WHO/VBC/71.255. WHO, Geneva.
- WHO. 1973 - Lutte antivectorielle en santé internationale. WHO, Geneva, 156 pp.
- WHO. 1974 - Manuel pratique de lutte antilarvaire dans les programmes antipaludiques. WHO, Geneva, 205 pp.
- WHO. 1975 - Instructions for determining the susceptibility or resistance of cockroaches to insecticides. WHO/VBC/75.807. WHO, Geneva, 3 pp.
- WHO. 1975 - Manuel de protection individuelle et collective contre le malaria. WHO, Geneva, 58 pp.
- WHO. 1976 - Criteria and meaning of tests for determining the susceptibility or resistance of insects to insecticides. VBC/76.2. WHO, Geneva, 6 pp.

- WHO. 1980 - Environmental management for vector control. 4th report of the WHO Expert Committee on Vector Biology and Control. Technical Reports Series 649. WHO, Geneva, 75 pp.
- WHO. 1981 - Instructions for determining the susceptibility or resistance of fleas to insecticides. WHO/VBC/81.815. WHO, Geneva, 6 pp.
- WHO. 1981 - Instructions for determining the susceptibility or resistance of body lice and head lice to insecticides. WHO/VBC/81.808. WHO, Geneva, 5 pp.
- WHO. 1981 - Instructions for determining the susceptibility or resistance of mosquito larvae to insecticides. WHO/VBC/81.807. WHO, Geneva, 6 pp.
- WHO. 1981 - Instructions for determining the susceptibility or resistance of adult mosquitos to organochlorine, organophosphate and carbamate insecticides - Establishment of the base-line. WHO/VBC/81.805. WHO, Geneva, 6 pp.
- WHO. 1981 - Instructions for determining the susceptibility or resistance of adult mosquitos to organochlorine, organophosphate and carbamate insecticides - Diagnostic test. WHO/VBC/81.806. WHO, Geneva, 7 pp.
- WHO. 1981 - Instructions for determining the susceptibility or resistance of adult blackflies, sandflies and biting midges to insecticides. WHO/VBC/81.810. WHO, Geneva, 6 pp.
- WHO. 1981 - Instructions for determining the susceptibility or resistance of adult ticks to insecticides. WHO/VBC/81.814. WHO, Geneva, 4 pp.
- WHO. 1981 - Instructions for determining the susceptibility or resistance of houseflies, tsetse, stableflies, blowflies, etc. to insecticides. WHO/VBC/81.813. WHO, Geneva, 5 pp.
- WHO. 1981 - Instructions for determining the susceptibility or resistance of adult bed-bugs to insecticides. WHO/VBC/81.809. WHO, Geneva, 5 pp.
- WHO. 1981 - Instructions for determining the susceptibility or resistance of blackfly larvae to insecticides. WHO/VBC/81.811. WHO, Geneva, 5 pp.
- WHO. 1982 - Bed bugs. WHO/VBC/82.857. WHO, Geneva, 9 pp.
- WHO. 1982 - Manual on environmental management for mosquito control, with special emphasis on malaria vectors. WHO offset publication 66. WHO, Geneva, 283 pp.
- WHO. 1983 - Biological control of vectors of disease. 6th report of the WHO Expert Committee on Vector Biology and Control. Technical Report Series 679. WHO, Geneva, 39 pp.
- WHO. 1984 - Chemical methods for the control of arthropod vectors and pests of public health importance. WHO, Geneva, 108 pp.
- WHO. 1985 - Bed bugs. Training and Information Guide. VBC/TS/85.2. WHO, Geneva, 26 pp.
- WHO. 1985 - Fleas. Training and Information Guide. VBC/TS/85.1. WHO, Geneva, 55 pp.
- WHO. 1985 - Lice. Training and Information Guide. VBC/TS/85.3. WHO, Geneva, 35 pp.



- WHO. 1985 - Normes pour les pesticides utilisés en santé publique. WHO, Geneva, 384 pp.
- WHO. 1985 - Specifications for pesticides used in public health. 6th ed. WHO, Geneva, 384 pp.
- WHO. 1986 - La trypanosomiase africaine: épidémiologie et lutte. Rapport d'un Comité d'experts de l'OMS. Série Rapports techniques 739. WHO, Geneva, 144 pp.
- WHO. 1988 - La lutte contre la filariose lymphatique, manuel à l'intention des personnels de santé. WHO, Geneva, 93 pp.
- WHO. 1989 - Geographical distribution of arthropod-borne diseases and their principal vectors. WHO/VBC/89.967. WHO, Geneva. 132 pp.
- WHO. 1989 - The use of impregnated bednets and other materials for vector-borne disease control. WHO/VBC/89.981. WHO, Geneva, 45 pp.
- WHO. 1990 - Health education in the control of schistosomiasis. WHO, Geneva, 61 pp.
- WHO. 1991 - Insect and Rodent Control through Environmental Management. A Community Action Programme. WHO, Geneva, case containing 1 book of 107 pp. + 62 plates and 7 games.
- WHO. 1991 - Matériel de lutte contre les vecteurs, 3ème éd. WHO, Geneva, 323 pp.
- WHO. 1991 - The housefly. Training and Information Guide. WHO/VBC/90.987. WHO, Geneva, 62 pp.
- WHO. 1992 - Lymphatic filariasis: the disease and its control. 5th report of the WHO Expert Committee on Filariasis. Technical Report Series 821. WHO, Geneva, 71 pp.
- WHO. 1992 - Résistance des vecteurs aux pesticides. 15ème Rapport du Comité OMS d'experts de la biologie des vecteurs et de la lutte antivectorielle. Série de Rapports techniques 818. WHO, Geneva, 68 pp.
- WHO. 1992 - The role of mollusciciding in schistosomiasis control. WHO/SCHIST/92.107. WHO, Geneva, 34 pp.
- WHO. 1993 - Lutte contre le schistosomiase. 2ème rapport du Comité OMS d'experts. Série Rapports techniques. WHO, Geneva, 99 pp.
- WHO. 1994 - Lymphatic filariasis infection and disease: control strategies. TDR/CTD/FIL/Penang/94.1. WHO, Penang, 30 pp.

WHO publications can be obtained through one of the Regional Offices or directly from WHO Head Office at the following address:

World Health Organization  
Distribution and Sale of Publications  
1211 Geneva 27, Switzerland

## Annex 1. Some arthropods and their importance to health

CLASS	ORDER	FAMILY	GENERA	MEDICAL IMPORTANCE
ARACHNIDA	Acarina	Ixodidae (hard ticks)	<i>Ixodes</i>	Tick paralysis. Vectors of spirochaetes (Lyme disease)
			<i>Rhipicephalus</i>	rickettsiae (spotted and boutonneuse fevers), arboviruses
			<i>Hyalomma</i>	(encephalitis and haemorrhagic fevers), bacteria
			<i>Dermacentor</i>	(tularaemia)
INSECTA	Argasidae (soft ticks)	Argasidae (soft ticks)	<i>Ornithodoros</i>	Vectors of spirochaetes (tick-borne relapsing fever),
			<i>Argas</i>	rickettsiae (Q-fever), arboviruses (African swine fever among pigs)
Araneida (spiders)	Sarcoptidae (mites)	Sarcoptes		Human scabies agent
				Poisonous
Scorpionida (scorpions)				Poisonous
Diptera	Culicidae (mosquitos)	Culicidae (mosquitos)	<i>Anopheles</i>	Vectors of protozoa (malaria), arboviruses (dengue and
			<i>Culex</i>	yellow fevers, encephalitis), filarial worms (filariasis)
			<i>Aedes</i>	
			<i>Mansonia</i>	
Muscidae (flies)	Muscidae (flies)	Muscidae (flies)	<i>Musca</i>	Mechanical transporters of bacteria, protozoa, intestinal
			<i>Stomoxys</i>	worms' eggs
			<i>Muscina</i>	
Glossinidae (tsetse-flies)	Glossinidae (tsetse-flies)	Glossina		Vectors of trypanosomes (gambian and rhodesian
				sleeping sickness)

<b>INSECTA</b>	<b>Diptera</b>	Calliphoridae (blowflies) and Sarcophagidae (fleshflies)	<i>Chrysomyia Sarcophaga</i>	Mechanical transporters of bacteria, protozoa, intestinal worms' eggs;	
			<i>Cordylobia Auchmeromyia</i>	myiasigenic or blood-sucking	
		Simuliidae (blackflies)	<i>Simulium</i>	Vectors of filarial worms (onchocerciasis)	
		Psychodidae (sandflies)	<i>Phlebotomus</i>	Vectors of protozoa (leishmaniasis)	
		Tabanidae (horseflies)	<i>Tabanus Chrysops</i>	Vectors of filarial worms (loiasis)	
	<b>Hemiptera</b>	Cimicidae (bugs)	<i>Cimex</i>	Nuisance	
	<b>Siphonaptera</b>	Pulicidae (fleas)	<i>Pulex Xenopsylla Ctenocephalides</i>	Vectors of bacilli (plague), rickettsiae (murine typhus), intestinal worms (tapeworm).	
			Tungidae (jigger fleas)	<i>Tunga</i>	Nuisance
		<b>Anoplura</b>	Pediculidae (lice)	<i>Pediculus Phthirus</i>	Ectoparasites (pediculosis). Vectors of rickettsiae (louse-borne typhus, trench fever), borrelia (relapsing fever)
	<b>Dictyoptera</b>	Blattidae (cockroaches)	<i>Blattella Blatta Periplaneta</i>	Mechanical transporters of bacteria, protozoa, intestinal worms' eggs	

## Annex 2. Morphological characteristics of some arthropods of medical importance

CLASS	ORDER	FAMILY
<p><b>ARACHNIDA</b></p> <p>Body in 2 segments: head and thorax united, articulated on the abdomen; no antennae; 4 pairs of legs in the adult stage</p>	<p><b>Acarina</b></p> <p>Non-segmented abdomen, generally united with the head-thorax segment; 3 pairs of legs in the larval stage; mouthpart equipped with a more or less developed rostrum</p>	<p><b>Ixodidae (hard ticks)</b></p> <p>Size from 7 to 15 mm; well-developed mouthpart equipped with a denticulate rostrum; hardened back, more developed on males than on females</p>
		<p><b>Argasidae (soft ticks)</b></p> <p>Size from 10 to 20 mm; well-developed mouthpart equipped with a denticulate rostrum; soft back</p>
		<p><b>Sarcoptidae (mites)</b></p> <p>Size under 0.5mm; rudimentary mouthpart, does not form any true denticulate rostrum</p>
	<p><b>Araneida (spiders)</b></p> <p>4 pairs of legs at all stages of development; mouthpart equipped with venom hooks (prebuccal appendages)</p>	

<p><b>ARACHNIDA</b></p> <p><b>Scorpionida</b> (scorpions) Abdomen prolonged in a "tail" formed by the last 6 segments, the last with a stinger containing a poison gland; mouthpart equipped with a pair of pincers</p>	
<p><b>INSECTA</b></p> <p>Body in 3 segments: head, thorax and abdomen; 1 pair of antennae; 3 pairs of legs at all stages of development</p>	<p><b>Diptera</b></p> <p>1 pair of well-developed wings and 1 residual pair forming halteres; biting or sucking mouthpart</p> <p><b>Culicidae</b> (mosquitos) Size from 5 to 20 mm; biting mouthpart; long antennae; scaly wings</p> <p><b>Muscidae</b> (flies) Size variable according to species; mouthpart of the sucking (Musca) or biting (Stomoxys) type; short antennae; dark in colour</p> <p><b>Glossinidae</b> (tsetse-flies) Size from 6 to 16 mm; biting mouthpart; short antennae; light brown or grey in colour</p> <p><b>Calliphoridae</b> (blowflies) Size from 5 to 10 mm; sucking mouthpart; short antennae; metallic blue or green in colour</p>

## Annex 2 (ctd). Morphological characteristics of some arthropods of medical importance

CLASS	ORDER	FAMILY
INSECTA	Diptera	<b>Sarcophagidae</b> (fleshflies) Size from 12 to 15 mm; sucking mouthpart, short antennae; grey in colour with 3 longitudinal black stripes on the thorax
		<b>Simuliidae</b> (blackflies) Size from 1 to 5 mm; biting mouthpart, short antennae; stumpy body; dark in colour
		<b>Psychodidae</b> (sandflies) Size from 1 to 4 mm; biting mouthpart; light in colour; very hairy; long antennae; hairy wings, raised in the insect at rest
		<b>Tabanidae</b> (horseflies) Size from 5 to 25 mm; biting mouthpart, short antennae; bulging eyes; often brightly coloured
		<b>Hemiptera</b> 2 pairs of wings, the first of which is partially chitinous; a dorso-ventrally flattened body; biting mouthpart
		<b>Cimicidae</b> (bugs) Size from 4 to 6 mm; brown in colour; residual wings, the second pair having totally disappeared; unable to fly

**INSECTA**

**Siphonaptera**

No wings; body flattened laterally; highly developed hind legs, hoppers; biting mouthpart

**Pulicidae (fleas)**

Tungidae (jigger flea)

Size from 0.8 to 6.5 mm; highly chitinised with no clear separation between head, thorax and abdomen

**Anoplura**

No wings; small eyes; short antennae; body flattened dorso-ventrally; biting mouthpart

**Pediculidae (lice)**

Size from 1.6 to 3.3 mm; mouthpart comprising a short proboscis that retracts into the head; feet have strong claws

**Dictyoptera**

Insects flattened dorso-ventrally, oval; head hidden under thorax; very long antennae; well developed wings; crushing mouthpart

**Blattidae (cockroaches)**

Size from 5 to 15 mm; legs covered in spikes; flexible tegument; from light brown to black in colour

## Annex 3. Reporting form for spraying operations

**PRODUCT USED (a):** \_\_\_\_\_ ; **TO CONTROL (b)** \_\_\_\_\_

**Country:** \_\_\_\_\_

**Date:** \_\_\_\_\_

**Camp:** \_\_\_\_\_

**Name of team leader:** \_\_\_\_\_

Place	Target zone	Treatment cycle	Dose in g of a.i./m <sup>2</sup>	Quantity used (litres or kg)	Application methods	Concentration of formulation in g/l	Concentration of formulation as %
Camp zone	- shelters (blindés)						
	- latrines						
	- garbage bins						
	- garbage pits						
	- staff accommodation						
Hospitals	- kitchens						
	- latrines						
	- garbage bins						
Schools	- latrines						
	- garbage bins						
Stores							
Drainage areas	- soakpits						
	- near water sources						
	- water points						

N.B. (a) = chemical product used and type of formulation [emulsifiable concentrate (EC), wettable powder (WP), etc.]

(b) = target organism



## Annex 4. Calculation of the quantity of solution and insecticide for use in treatments

When calculating the quantities of insecticide and water needed to prepare the necessary solutions for an insecticide treatment cycle, the following factors have to be considered:

- the number of units to be treated;
- the surface of each unit;
- the quantity of active ingredient that needs to be applied per m<sup>2</sup>;
- the concentration of insecticide in the formulation available or to be obtained;
- 40 ml of solution is necessary to spray 1 m<sup>2</sup>.

### Example:

To calculate the quantity of insecticide necessary for the residual treatment of 1,000 *blindés* each having a surface area of 50 m<sup>2</sup>, using deltamethrin 2.5 WP (wetable powder) at a dose of 0.025 g of a.i./m<sup>2</sup>, it is necessary to consider the following points:

- 1 kg of deltamethrin 2.5 WP contains 25 g of a.i.;
- 1 kg of deltamethrin 2.5 WP will therefore be sufficient to treat 1,000 m<sup>2</sup> or 20 *blindés*;
- 40 ml of solution must contain 0.025 g of a.i.;
- the treatment of one *blindé* therefore requires 2 litres of solution (40 ml x 50 m<sup>2</sup>), containing 1.25 g of a.i. equivalent to 50 g of deltamethrin 2.5 WP;
- to treat 1,000 *blindés*, 2,000 litres of water and 50 kilos of deltamethrin 2.5 WP will therefore be required.

## **Annex 5. Determination of the insecticide concentration for use in a sprayer**

When calculating the optimum concentration of active ingredient (a.i.) in the insecticide solution to be used in a spraying treatment, the following factors should be considered:

- quantity of a.i. per m<sup>2</sup> to be applied;
- throughput speed of the pump (nozzle type and tank pressure);
- speed and method of spraying (see section 14.3.)

### **Example:**

In order to determine the insecticide concentration for pirimiphos-methyl 50 CE treatment to be applied using a sprayer, the following points have to be considered:

- surfaces must be treated with 1 g of insecticide a.i. per m<sup>2</sup>;
- spraying speed must be regulated to spread 40 ml solution per m<sup>2</sup>;
- the formulation contains 50% of a.i.;
- so for 40 ml to contain 1 g of a.i., a litre of solution will have to contain 25 g, giving a 2.5% a.i. concentration.

### **Example:**

In order to determine the insecticide concentration for deltamethrin 2.5 WP treatment to be applied using a sprayer, the following points have to be considered:

- the surfaces must be treated with 0.025 g of insecticide a.i. per m<sup>2</sup>;
- spraying speed must be regulated to spread 40 ml solution per m<sup>2</sup>;
- the insecticide comes in a 2.5% concentrate formulation;
- so in order that 40 ml contain 0.025 g of a.i., a litre of solution will have to contain 0.625 g, giving a 0.0625% a.i. concentration.

## Annex 6. Preparation of a solution from an insecticide formulation

In order to prepare a suspension or a solution from a given formulation of a pesticide in wettable powder or emulsifiable concentrate form, the following formula must be applied:

$$X = \frac{A \times B \times D}{C}$$

where

X = quantity of formulation necessary

A = desired concentration

B = desired quantity of solution

C = concentration of a.i. in the formulation

D = 1 if X and B are expressed in kg or litres; D=8.33 if X and B are expressed in pounds or US gallons and D=10 if X and B are expressed in pounds or imperial (UK) gallons.

### Example:

To obtain 100 litres of a 2.5% solution from an insecticide formulation containing 50% a.i. :

$$\frac{2.5 \times 100 \times 1}{50} = 5$$

Therefore 5 kg or 5 litres of insecticide formulation have to be mixed with 100 litres of water to obtain the solution at the concentration required for filling the pumps.

**N.B.** When using powders for suspensions, the powder should be put into a receptacle with a little water, and mixed to obtain a paste. This paste should then be thinned by adding small quantities of water until the desired volume is attained and the resulting mixture poured through a filter into the tank.

## Annex 7. Preparation of a solution from an emulsifiable concentrate

To prepare a pesticide solution from a emulsifiable concentrate (EC), the following formula can be used:

$$X = \left[ \frac{A}{B} \right] - 1$$

where

X = quantity of water to add to 1 part of EC

A = concentration of EC

B = desired concentration of solution

### Example:

To obtain a 2.5% formulation of a 50% EC:

$$\left[ \frac{50}{2.5} \right] - 1 = 19$$

It is therefore necessary to mix 19 parts water to 1 part EC to obtain the required concentration.

## Annex 8. Calculation of the quantity and dilution of insecticide for use in impregnation of fabrics

In order to calculate the dilution of insecticide for use in impregnation of fabrics, the absorption capacity of the fabric per m<sup>2</sup> (which will vary according to its thickness and composition) has been taken into account.

The procedure is as follows:

- (a) calculate the total surface area of the fabric to be impregnated;
- (b) calculate the quantity of insecticide formulation required according to the following formula:

m<sup>2</sup> of fabric X g of a.i. per m<sup>2</sup> X 100  
concentration (%) of the insecticide formulation

$$\frac{\text{m}^2 \text{ of fabric X g of a.i. per m}^2 \times 100}{\text{concentration (\%)} \text{ of the insecticide formulation}}$$

- (c) calculate the absorption capacity by soaking the fabric or mosquito net in a basin containing a known quantity of water. Drain the fabric or net over the basin and measure the volume or weight of the water remaining in the basin;
- (d) add the quantity of formulation (point (b)) to the quantity of water that was found to have impregnated the fabric after draining (point (c)).

### Example:

To impregnate a 10 m<sup>2</sup> nylon mosquito net having a total absorption capacity of 500 ml water, using permethrin in a 50% emulsifiable concentrate at a dose of 0.5 g a.i. per m<sup>2</sup>:

$$\frac{10 \times 0.5 \times 100}{50} = 10 \text{ g of product i.e. 10 ml of permethrin 50\% EC}$$

10 ml of insecticide will, therefore, have to be mixed with 490 ml of water for each mosquito net (or 1 litre of insecticide with 50 litres of water for 100 mosquito nets).

## Annex 9. Calculation of the quantity of molluscicide for use in a waterway

To find out the flow rate of water, the speed has to be measured at the surface ( $V_s$ ) over a given distance using a float. The average speed ( $V_m$ ) is calculated using the following formula:

$$V_m = V_s \times 0.8$$

The  $V_m$  multiplied by the cross-section of the waterway gives the flow in  $m^3$  per second.

A concentration of 1 mg/l means that 1 g product is needed per  $m^3$  of water. In a waterway with a flow of 1  $m^3$  per sec., or 3,600  $m^3$  per hour, 3.6 kg of product per hour will therefore be required to obtain this concentration.

To obtain a concentration of 4 mg/l of 70% niclosamide in a waterway with a flow of 1  $m^3$  per sec. will require:

$$3.6 \times 4 \times \left[ \frac{100}{70} \right] = 20.6$$

or 20.6 kg of product per hour.

In a waterway with a flow of 3.5  $m^3$  per sec., and as the product has to remain in the water for 8 hours to eliminate the molluscs, it will be necessary to spread:

$$\frac{20.6 \times 3.5}{8} = 9$$

or 9 kg of 70% niclosamide per hour.

Printed by Centro Stampa De Vittoria srl,  
Via degli Aurunci 19, Rome, Italy

April 1997